



**ΑΑΔΕ**

Independent Authority  
for Public Revenue (IAPR)

# myDATA

# Electronic Books AADE

---

**Technical description of REST API interfaces  
for Data Transmission and Retrieval for ERP  
Users**

Version 1.0.9 – July 2024

## Table of contents

1	Introduction.....	4
2	Objective.....	4
3	Technical requirements for invoicing programs.....	6
4	Description of RESTAPI.....	6
4.1	Interface description.....	6
4.1.1	User registration.....	7
4.1.2	Using services.....	9
4.2	Services.....	9
4.2.1	SendInvoices.....	9
4.2.2	SendIncomeClassification.....	9
4.2.3	SendExpensesClassification.....	11
4.2.4	SendPaymentsMethod.....	13
4.2.5	CancelInvoice.....	14
4.2.6	RequestDocs.....	15
4.2.7	RequestTransmittedDocs.....	16
4.2.8	RequestMyIncome.....	17
4.2.9	RequestMyExpenses.....	18
5	InvoiceDoc description.....	19
5.1	Party.....	23
5.1.1	Address.....	25
5.2	Payment Method.....	25
5.2.1	Provider Payment Signature.....	27
5.2.2	Payment Signature by the Public Finance Management System (PFMS) using Enterprise Resource Planning (ERP) software.....	27
5.3	Invoice header.....	29
5.3.1	Other Correlated Entities.....	32
5.3.2	Other General Delivery Details.....	32
5.4	Invoice details.....	35
5.4.1	Activity Undertaking Declaration (POL 1177/2018, Article 27).....	40
5.5	Taxes totals.....	41
5.6	Invoice summary.....	42
5.7	Other Transport Means Information.....	43
5.8	Income classification.....	43
5.9	Expenses classification.....	44

6	Responses .....	48
6.1	Data submission .....	48
6.2	Data retrieval .....	51
6.3	Receipt of Income - Expenses data .....	52
6.4	Receiving VAT Information .....	54
7	Errors .....	57
7.1	Technical errors .....	57
7.2	Operational errors .....	58
8	Appendix .....	65
8.1	Invoice type .....	65
8.2	VAT category .....	70
8.3	VAT Exemption Cause .....	70
8.4	Withholding taxes .....	72
8.5	Other taxes .....	72
8.6	Stamp duty .....	74
8.7	Fees .....	74
8.8	Income Classification Category .....	74
8.9	Income Classification Type .....	76
8.10	Expenses Classification Category .....	77
8.11	Expenses Classification Type .....	77
8.12	Payment methods .....	80
8.13	Unit of measurement .....	81
8.14	Purpose of movement .....	81
8.15	Remark .....	81
8.16	Line Type .....	82
8.17	Fuel Codes .....	83
8.18	Document Deviation Type .....	84
8.19	Special Document Category .....	84
8.20	Entity Type Category .....	85
9	History of changes .....	85
9.1	Version 0.5.1 .....	85
9.2	Version 0.6 .....	86
9.3	Version 0.6.1 .....	87
9.4	Version 1.0 .....	87
9.5	Version 1.0.1 .....	88
9.6	Version 1.0.2 .....	88
9.7	Version 1.0.3 .....	89

9.8	Version 1.0.4 .....	90
9.9	Version 1.0.5 .....	90
9.10	Version 1.0.6 .....	91
9.11	Version 1.0.7 .....	91
9.12	Version 1.0.8 .....	92
9.13	Version 1.0.9 .....	93

## 1 Introduction

### **myDATA (my Digital Accounting and Tax Application).**

Is the name of the new electronic platform by which AADE introduces electronic books into the daily lives of businesses.

Electronic Books is a very important step in the digital transformation of the State and the businesses. Our goal is primarily to serve businesses by providing an innovative digital platform for fulfilling their tax obligations, which will lead to the automation of tax declaration and will relieve them of their current obligations, such as Filing of Customers-Suppliers Lists.

The myDATA online platform provides easy solutions for everyone. Both for businesses that have computerized accounting systems that can submit the necessary data in bulk and automated, and for other companies that can submit data in a simple way, through a registration form on the website of AADE.

## 2 Objective

For the needs of businesses and professionals with computerized accounting systems, AADE provides a RESTAPI interface installed on public cloud infrastructure (Microsoft Azure). This enables ERP systems or other accounting-trading systems to seamlessly interconnect with AADE for the exchange of relevant data.

Specifically, for an enterprise using an information system that uses the relevant API, the features offered are:

- Send data for the invoices it issues.

- Sending income classification for the invoices it issues.
- Retrieve data of invoices issued for it and submitted by the respective issuers to AADE.
- Send expense classification data to AADE.

This document describes the above services and the technical specifications necessary to implement the relevant calls of the RESTAPI interface.

### 3 Technical requirements for invoicing programs

The following technologies are used in order to establish a connection with the interface

- HTTPS - Secure HTTP
- Webservice
- REST API - REST interface required for data reporting process
- XML - eXtensible Markup Language

The interface is accessible to any invoicing program capable of sending HTTP messages and creating schema-conformant XML, as specified in the present specification.

In addition to the relevant data, the software should be able to simultaneously and automatically send the necessary information to identify the user through the same HTTPS call.

### 4 Description of RESTAPI

In summary, the interface provides the following services:

- **/SendInvoices**: submit one or more invoices, including corrected/modified
- **/RequestDocs**: retrieve one or more invoices, classifications or invoice cancelations that other users have submitted
- **/RequestTransmittedDocs**: retrieve one or more invoices, classifications or invoice cancelations the user has submitted
- **/SendIncomeClassification**: submit income classification for one or more already submitted invoices
- **/SendExpensesClassification**: submit expenses classification for one or more already submitted invoices
- **/CancelInvoice**: cancels an invoice
- **/RequestMyIncome** : Process of obtaining information regarding the user's income
- **/RequestMyExpenses** : Process of obtaining information regarding the user's expenses

A detailed description of the services is described later in this document.

#### 4.1 Interface description

#### 4.1.1 User registration

Using interface services requires a user authentication process. Authentication is accomplished by sending a username and a subscriptionkey in the headers of every call. The subscriptionkey is a string, unique per user, and is common for all interface services.

In order for a user to obtain the above credentials, he/she must create an account in the registry of the interface through a special registration process offered by the myDATA online platform.

The registration process for the offered services of the myDATA REST API, will be done through the application that is available at the URL of the myDATA platform:

<https://www1.aade.gr/saadeapps2/bookkeeper-web>

Initially the user is asked to log in with the taxisnet credentials, and then the following page appears:

The screenshot displays the myDATA platform interface. At the top left is the AΑΔΕ logo (Ανεξάρτητη Αρχή Δημοσίων Εσόδων) and a menu icon. The myDATA logo is centered, with the tagline 'Digital Accounting & Tax Application' to its right. A user profile icon is on the top right. The main content area features a 'Welcome to myDATA of IAPR' header. Below this, a paragraph explains that myDATA (my Digital Accounting and Tax Application) is a new electronic platform for IAPR. Further text describes the benefits of electronic books, such as reducing administrative costs and enhancing transparency. A list of features is provided: Summarized Book, Detailed Book, Insert new invoice, Search Invoices, Subscribe to myDATA REST API, and Declarations of invoicing using Providers. A final button for 'Subscribe to Timologio' is also present.

**Summarized Book**  
Review your daily activity

**Detailed Book**  
Analyze your activity per month

**Insert new invoice**  
Insert a new invoice in your book

**Search Invoices**  
Search your invoices

**Subscribe to myDATA REST API**  
Register at myDATA REST API

**Declarations of invoicing using Providers**  
Declare the exclusive issuance and acceptance of receiving invoices through Provider

**Subscribe to Timologio**  
Subscribe to timologio and issue the invoices of your business

On the above page, the user selects "Registration form in the myDATA REST API" and in the myDATA REST API

form of the page that appears selects New registration. In the form that appears after filling in username, password and email, select "Add registration". In the event of a successful registration, the user is created in the relevant RESTAPI registry, and a special subscription key is provided that the user will use to identify him/her when calling interface services. The subscription key is the value of the "API Code" column of the following screen, in which all the subscription keys created by the user are displayed.

The screenshot shows a web interface for registering for the myDATA REST API. At the top, there are logos for AΑΔΕ (Ανεξάρτητη Αρχή Δημοσίων Εσόδων) and myDATA (Digital Accounting & Tax Application). The main heading is "Subscribe to myDATA REST API".

Below the heading, there are two main sections:

- Registry data:** A table with three columns: TIN, Name, and Address. The table is currently empty.
- Users:** A table with six columns: Subscription key, Username, E-mail address, Registration Date, Status, and Remove. The table is currently empty, and the 'Remove' column contains a trash icon.

After the registration step the user will be able to log in to the portal of the interface with their account details from where they can view and change the subscriptionkey.

The use of each function of the interfaces is made by sending an HTTPS call (GET or POST, depending on the function) to the corresponding URL link.

The call must contain the appropriate header which will contain information necessary for the identification of the user and a body in XML format, the structure of which will depend on the service called.

In the submission services (POST call) the user can send one or more objects, embedding them in the body of the call in a special XML format, (invoice / accounting records or characterizations). The response may contain, for each invoice, one or more error messages or a successful submission message. In case an item is resubmitted, having the same identifiers as a previously sent item, the latter is retained in the Electronic Books database as valid, and the previous one is canceled.

In the services of receiving or simply canceling a invoice (GET type calls) the user during the call will send as parameters the unique numbers of the invoice that interest him.

**\*Note:** For the development and testing phase, the registration process for myDATA REST API services will be done through the application available at URL:

<https://mydata-dev-register.azurewebsites.net/>



## 4.1.2 Using services

Each call must contain the following headers in the form of pair-values, which is necessary for user identification. In case of incorrect information the user will receive an error message.

KEY	Data Type	VALUE	DESCRIPTION
aade-user-id	String	{User name}	User name of the account
ocp-apim-subscription-key	String	{Subscription Key}	User's subscription key

By identifying the user through the headers, the interface will also gain access to the VAT number the user had stated when registering, so that it would not be necessary to submit it in every call.

## 4.2 Services

### 4.2.1 SendInvoices

The call of the method SendInvoices is available through the following URL:  
<https://mydatapi.aade.gr/myDATA/SendInvoices>

The call has the following characteristics:

- /sendInvoices (POST)
- Header as described in section 4.2.2
- Body in xml format containing the InvoicesDoc element, which contains one or more invoices. The structure of the element InvoicesDoc is described by type AadeBookInvoiceType and is discussed in Chapter 5

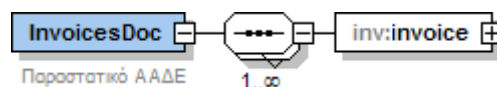

**\*Note:** For the development and testing phase, the method is available at URL:

<https://mydataapidev.aade.gr/SendInvoices>

### 4.2.2 SendIncomeClassification

The call of the method SendIncomeClassification is available through the following URL:

<https://mydatapi.aade.gr/myDATA/SendIncomeClassification>

The call has the following characteristics:

- /SendIncomeClassification (POST)
- Header as described in section 4.2.2
- Body in xml format containing one or more InvoiceIncomeClassificationType elements. The structure of the element is :

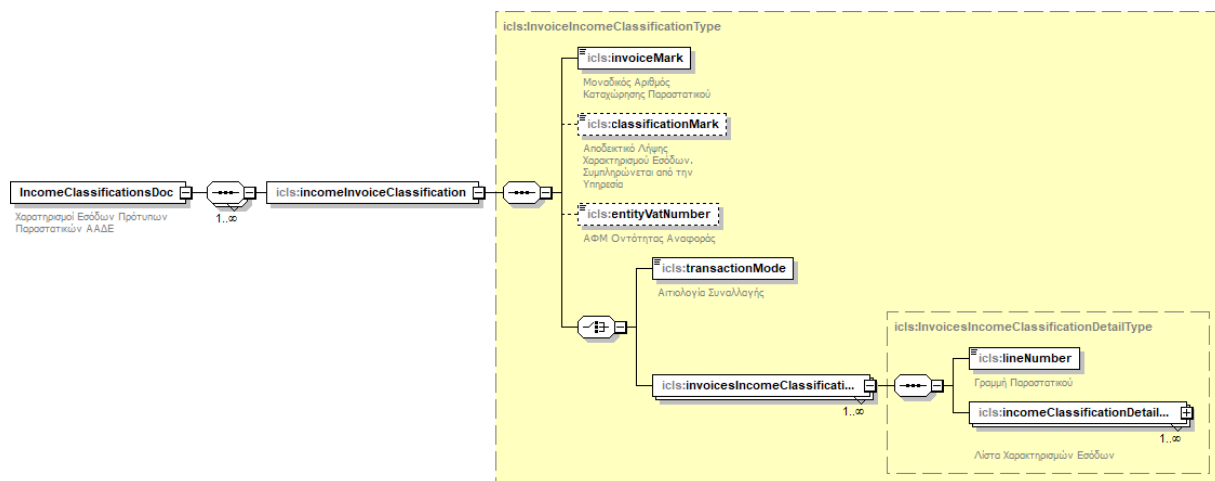

Field	Type	Mandatory	Description	Valid values
invoiceMark	xs:long	Yes	Unique Invoice Registration Number	
classificationMark	xs:long	No	Unique Classification Registration Number	
entityVatNumber	xs:string	No	VAT Reference Entity	
transactionMode	xs:int	Yes <sup>(3)</sup>	Transaction Type	1 = Reject 2 = Deviation
lineNumber	xs:int	Yes	Line number	
incomeClassificationDetailData	IncomeClassificationType	Yes <sup>(3)</sup>	Income Classification Type	

**Remarks**

- 1) Field classificationMark is filled in by the service
- 2) When field transactionMode has value 1, means rejection of invoice due to disagreement ,when the field has value 2 means variance in amounts
- 3) User must include either field transactionMode, either a list of invoicesIncomeClassificationDetails elements
- 4) Every invoicesIncomeClassificationDetails element contains lineNumber and a list of invoiceIncomeClassificationDetailData elements
- 5) Field lineNumber refers to the corresponding line number of the invoice identified by the given mark

- 6) In that case and only if the method is called by a third party (such as a representative of legal person or accountant), the VAT number of the entity mentioned in the document description is sent via the entityVatNumber field, otherwise this field remains blank

**\*Note:** For the development and testing phase, the method is available at URL: <https://mydataapidev.aade.gr/SendIncomeClassification>

### 4.2.3 SendExpensesClassification

The call of the method SendExpensesClassification is available through the following URL:

<https://mydatapi.aade.gr/myDATA/SendExpensesClassification>

The call has the following characteristics:

- /SendExpensesClassification (POST)
- Header as described in section 4.2.2
- Body in xml format containing one or more InvoiceExpensesClassificationType elements. The structure of the element is:

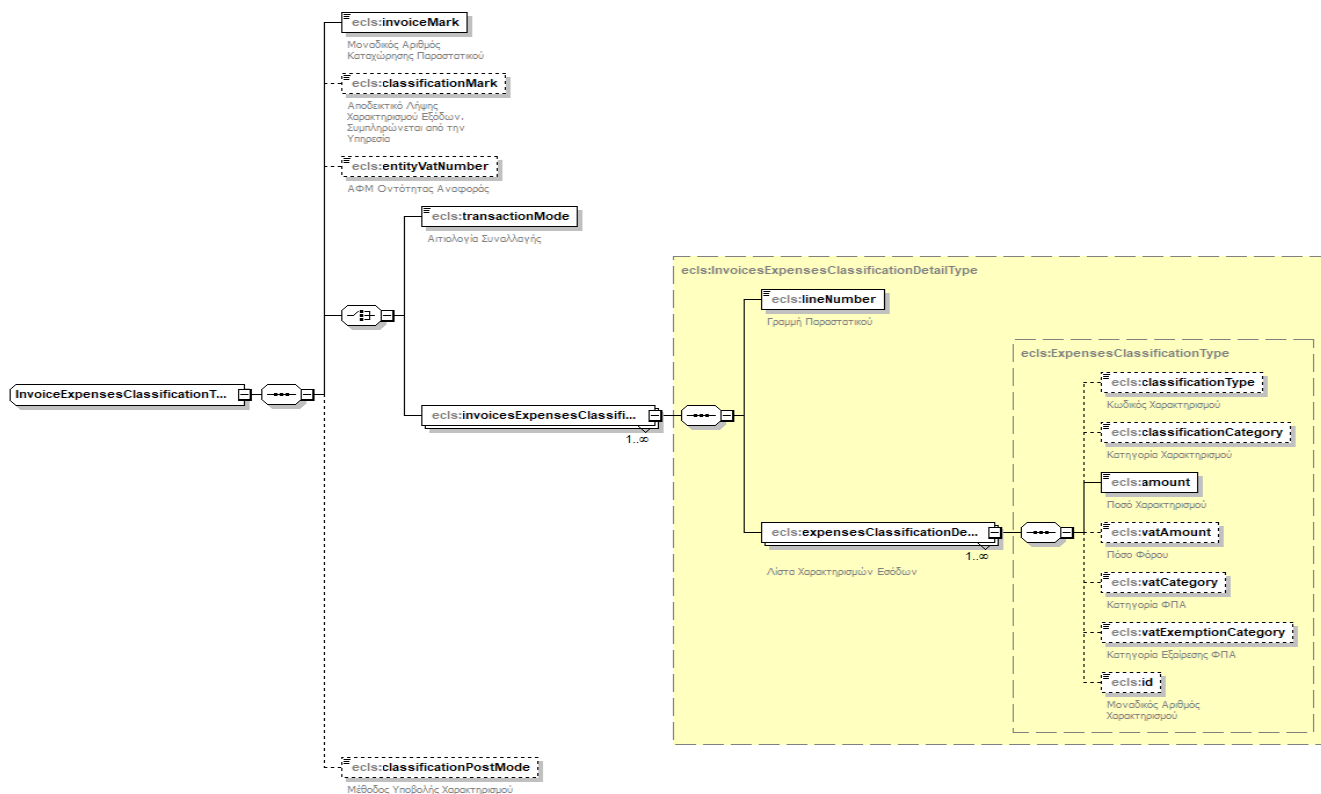

Field	Type	Mandatory	Description	Valid values
invoiceMark	xs:long	Yes	Unique Document Registration Number	
classificationMark	xs:long	No	Unique Characterization Registration Number	
entityVatNumber	xs:string	No	Tax Identification Number (TIN) of the Referenced Entity	entityVatNumber
transactionMode	xs:int	Yes (choice)	Transaction Type	1 = Reject 2 = Deviation
lineNumber	xs:int	Yes(choice)	Line Number	
expensesClassificationDetailData	ExpensesClassificationType	Yes(choice)		

## Remarks

- 1) The field `classificationMark` is filled in by the service
- 2) The `transactionMode` field, when set to 1, indicates the rejection of the document due to disagreement. When set to 2, it signifies a discrepancy in the amounts
- 3) The user can include either the `transactionMode` element or a list of elements in `invoicesExpensesClassificationDetails`
- 4) Each `invoicesExpensesClassificationDetails` element contains a `lineNumber` and a list of `expensesClassificationDetailData` elements
- 5) The `lineNumber` field refers to the corresponding line number of the original document with the unique registration number as in the `mark` field
- 6) In the case, and only in the case, where the method is called by a third party (such as a legal representative or accountant), the VAT number of the entity referenced in the document's characterization is sent through the `entityVatNumber` field; otherwise, this field remains empty.

**\*Note:** For the development and testing phase, the method is available at the following URL:

<https://mydataapidev.aade.gr/SendExpensesClassification>

## 4.2.4 SendPaymentsMethod

The invocation of the `SendPaymentsMethod` method is available through the following URL:

<https://mydatapi.aade.gr/myDATA/SendPaymentsMethod>

The call possesses the following characteristics:

- `/SendPaymentsMethod`, POST method
- Headers as specified in paragraph 4.1.2
- Body consisting of one or more `PaymentMethodType` elements.

The type is described by the following chart:

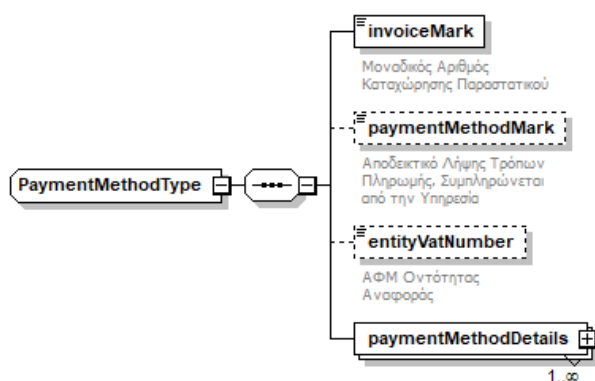

Field	Type	Mandatory	Description	Valid Values
invoiceMark	xs:long	Yes	Unique Document Registration Number	
paymentMethodMark	xs:long	No	Unique Payment Method Registration Number	
entityVatNumber	xs: string	No	VAT Number of the Reporting Entity	
paymentMethodDetails	PaymentMethodDetailType	Yes	Payment Methods	

Observations:

1. The paymentMethodMark field is populated by the service.
2. When the method is called by a third party (e.g., a provider), the reference VAT number is sent through the entityVatNumber field; otherwise, the field remains empty.
3. The PaymentMethodDetailType object is elaborated in detail in paragraph 5.2.
4. When using the method, at least one PaymentMethodDetailType object per document must be of type POS.
5. The total amount per PaymentMethodType object must equal the totalGrossValue of the document corresponding to the invoiceMark.

**\*Note:** For the development and testing phase, the method is available at the URL: <https://mydataapidev.aade.gr/SendPaymentsMethod>.

#### 4.2.5 CancelInvoice

This method (POST method) is used to cancel one invoice without sending a new one. User call the method by submitting as a parameter the MARK of the invoice he/she wants to cancel. In that case and only if the method is called by a third party (such as a representative of legal person or an accountant), the VAT number of the entity that issued the document to be canceled is sent through the entityVatNumber parameter, otherwise this parameter does not need to be sent. No xml body is required.

**[https://mydatapi.aade.gr/myDATA/CancelInvoice?\[mark\]&\[entityVatNumber\]](https://mydatapi.aade.gr/myDATA/CancelInvoice?[mark]&[entityVatNumber])**

Name of Parameter	Type	Mandatory	Description
Mark	xs:long	Yes	Unique Invoice Registration Number
entityVatNumber	xs:string	No	VAT Entity

In case of success, the user receives the MARK of cancellation. Otherwise an error message s returned.

**\*Note:** For the development and testing phase, the method is available at URL:

[https://mydataapidev.aade.gr/CancelInvoice?\[mark\]&entityVatNumber](https://mydataapidev.aade.gr/CancelInvoice?[mark]&entityVatNumber)

#### 4.2.6 RequestDocs

With this method, the user receives documents, characterizations, cancellations of documents submitted by other users that concern them, as well as information if a document has been rejected by the counterparty through the discrete call of the method for sending expense characterizations (field `transactionMode`). In the specific case where the method is called by a third party (such as a legal representative or accountant), the VAT number of the entity for which the search is performed is sent through the `entityVatNumber` parameter; otherwise, this parameter does not need to be sent. This is accomplished through an HTTP GET request of the method, using the following parameter, which serves as the search criterion.

This is achieved through an HTTP GET request of the method, using the following parameter, which serves as the search criterion.

[https://mydatapi.aade.gr/myDATA/RequestDocs?mark={mark}&dateFrom\]&dateTo\]&entityVatNumber\]&counterVatNumber\]&invType\]&maxMark\]&nextPartitionKey\]&nextRowKey\]](https://mydatapi.aade.gr/myDATA/RequestDocs?mark={mark}&dateFrom]&dateTo]&entityVatNumber]&counterVatNumber]&invType]&maxMark]&nextPartitionKey]&nextRowKey])

Name of Parameter	Mandatory	Description
Mark	Yes	Unique Invoice Registration Number
entityVatNumber	No	Entity VAT Number
dateFrom	No	Start of search interval for the date of issue
dateTo	No	End of search interval for the date of issue
receiverVatNumber	No	VAT number of the counterparty
invType	No	Type of document
maxMark	No	Maximum number of MAPK
nextPartitionKey	No	Parameter for partial retrieval of results
nextRowKey	No	Parameter for partial retrieval of results

The call returns those items that relate to the user and have a Unique Registration Number identifier greater than the parameter.

**Note:**

1. If the results exceed the maximum limit, they are returned in increments. The `nextPartitionKey` and `nextRowKey` fields will be included in each part of the results and will be used as parameters in the call to receive the next part of results.

2. If one of the above parameters has no value, the search is performed for all possible values of this field, as before
3. In case only one of dateFrom, dateTo is received, the search will be performed only for the date given in the other parameter. If both parameters have a value, the search will be performed for the interval from dateFrom to dateTo.
4. If a value is assigned to the maxMark parameter, those records with a mark less than or equal to this value will be returned
5. The values of the receiverVatNumber and invType parameters are always applied with the equal operator
6. The invType parameter is given as a value the number corresponding to the specific type according to table 8.1 of the Appendix

**\*Note:** For the development and testing phase, the method is available at URL:

[https://mydataapidev.aade.gr/RequestDocs?mark={mark}&dateFrom\]&dateTo\]&entityVatNumber\]&counterVatNumber\]&invType\]&maxMark\]&nextPartitionKey\]&nextRowKey](https://mydataapidev.aade.gr/RequestDocs?mark={mark}&dateFrom]&dateTo]&entityVatNumber]&counterVatNumber]&invType]&maxMark]&nextPartitionKey]&nextRowKey)

#### 4.2.7 RequestTransmittedDocs

With this method the user receives documents, markings and cancellations of documents submitted by him/her and concerning him/her.

This is done via an HTTP GET call to the method, with the following parameter acting as a search criterion.

[https://mydatapi.aade.gr/myDATA/RequestTransmittedDocs?mark={mark}&dateFrom\]&dateTo\]&entityVatNumber\]&counterVatNumber\]&invType\]&maxMark\]&nextPartitionKey\]&nextRowKey](https://mydatapi.aade.gr/myDATA/RequestTransmittedDocs?mark={mark}&dateFrom]&dateTo]&entityVatNumber]&counterVatNumber]&invType]&maxMark]&nextPartitionKey]&nextRowKey)

Name of Parameter	Mandatory	Description
mark	Yes	Unique Invoice Registration Number
dateFrom	No	Start of search interval for the date of issue
dateTo	No	End of search interval for the date of issue
receiverVatNumber	No	VAT number of the counterparty
invType	No	Type of document
maxMark	No	Maximum number of MAPK
nextPartitionKey	No	Parameter for partial retrieval of results
nextRowKey	No	Parameter for partial retrieval of results

The call returns those items that relate to the user and have a Unique Registration Number identifier greater than the parameter.



**Note:**

1. If the results exceed the maximum limit, they are returned in increments. The nextPartitionKey and nextRowKey fields will be included in each part of the results and will be used as parameters in the call to receive the next part of results.
2. If one of the above parameters has no value, the search is performed for all possible values of this field, as before
3. In case only one of dateFrom, dateTo is received, the search will be performed only for the date given in the other parameter. If both parameters have a value, the search will be performed for the interval from dateFrom to dateTo.
4. If a value is assigned to the maxMark parameter, those records with a mark less than or equal to this value will be returned
5. The values of the receiverVatNumber and invType parameters are always applied with the equal operator
6. The invType parameter is given as a value the number corresponding to the specific type according to table 8.1 of the Appendix

**\*Note:** For the development and testing phase, the method is available at URL:

[https://mydataapidev.aade.gr/RequestTransmittedDocs?mark={mark}&dateFrom\]&dateTo\]&entityVatNumber\]&counterVatNumber\]&invType\]&maxMark\]&nextPartitionKey\]&nextRowKey\]](https://mydataapidev.aade.gr/RequestTransmittedDocs?mark={mark}&dateFrom]&dateTo]&entityVatNumber]&counterVatNumber]&invType]&maxMark]&nextPartitionKey]&nextRowKey])

#### 4.2.8 RequestMyIncome

With this method, the user receives information about his income for a certain period of time.

This is done through an HTTP GET call to the method, with the following parameters as search criteria.

[https://mydatapi.aade.gr/myDATA/RequestMyIncome?\[dateFrom\]&\[dateTo\]&\[counterVatNumber\]&\[entityVatNumber\]&\[invType\]&\[nextPartitionKey\]&\[nextRowKey\]](https://mydatapi.aade.gr/myDATA/RequestMyIncome?[dateFrom]&[dateTo]&[counterVatNumber]&[entityVatNumber]&[invType]&[nextPartitionKey]&[nextRowKey])

Name of Parameter	Mandatory	Description
dateFrom	Yes	Unique registration number
dateTo	Yes	Unique registration number
counterVatNumber	No	VAT number of the counterparty
entityVatNumber	No	Reference VAT number
invType	No	Type of document
nextPartitionKey	No	Parameter for the batch download of results
nextRowKey	No	Parameter for the batch download of results

The call returns rows of information about the user's revenue for a specific closed calendar interval defined by the values of the dateFrom and dateTo parameters. Optionally, the search

can be performed with additional filters specific contractor VAT number and specific document type.

Notes:

1. If the entityVatNumber parameter has a value, the search will be performed for this VAT number, otherwise for the VAT number of the user calling the method
2. Date parameters should be entered in dd/MM/yyyy format
3. When an optional parameter is not entered, the search is performed for all possible values that this field could have
4. In case the search results exceed the maximum allowed size, the user will receive them in parts. The nextPartitionKey and nextRowKey fields will be included in each result partition and will be used as parameters in the call to get the next result partition

**\*Note:** For the development and testing phase, the method is available at the URL:

[https://mydataapidev.aade.gr/RequestMyIncome?\[dateFrom\]&\[dateTo\]&\[counterVatNumber\]&\[entityVatNumber\]&\[invType\]&\[nextPartitionKey\]&\[nextRowKey\]](https://mydataapidev.aade.gr/RequestMyIncome?[dateFrom]&[dateTo]&[counterVatNumber]&[entityVatNumber]&[invType]&[nextPartitionKey]&[nextRowKey])

#### 4.2.9 RequestMyExpenses

The same applies to this method as to the RequestMyIncome method (see par. 4.3.7, except that the user receives information about his/her expenses

**\*Note:** For the development and testing phase, the method is available at the URL:

[https://mydataapidev.aade.gr/RequestMyExpenses?\[dateFrom\]&\[dateTo\]&\[counterVatNumber\]&\[entityVatNumber\]&\[invType\]&\[nextPartitionKey\]&\[nextRowKey\]](https://mydataapidev.aade.gr/RequestMyExpenses?[dateFrom]&[dateTo]&[counterVatNumber]&[entityVatNumber]&[invType]&[nextPartitionKey]&[nextRowKey])

## 5 InvoiceDoc description

This section provides a detailed description of the content of the document (of type AadeBookInvoiceType). Its structure is described below:

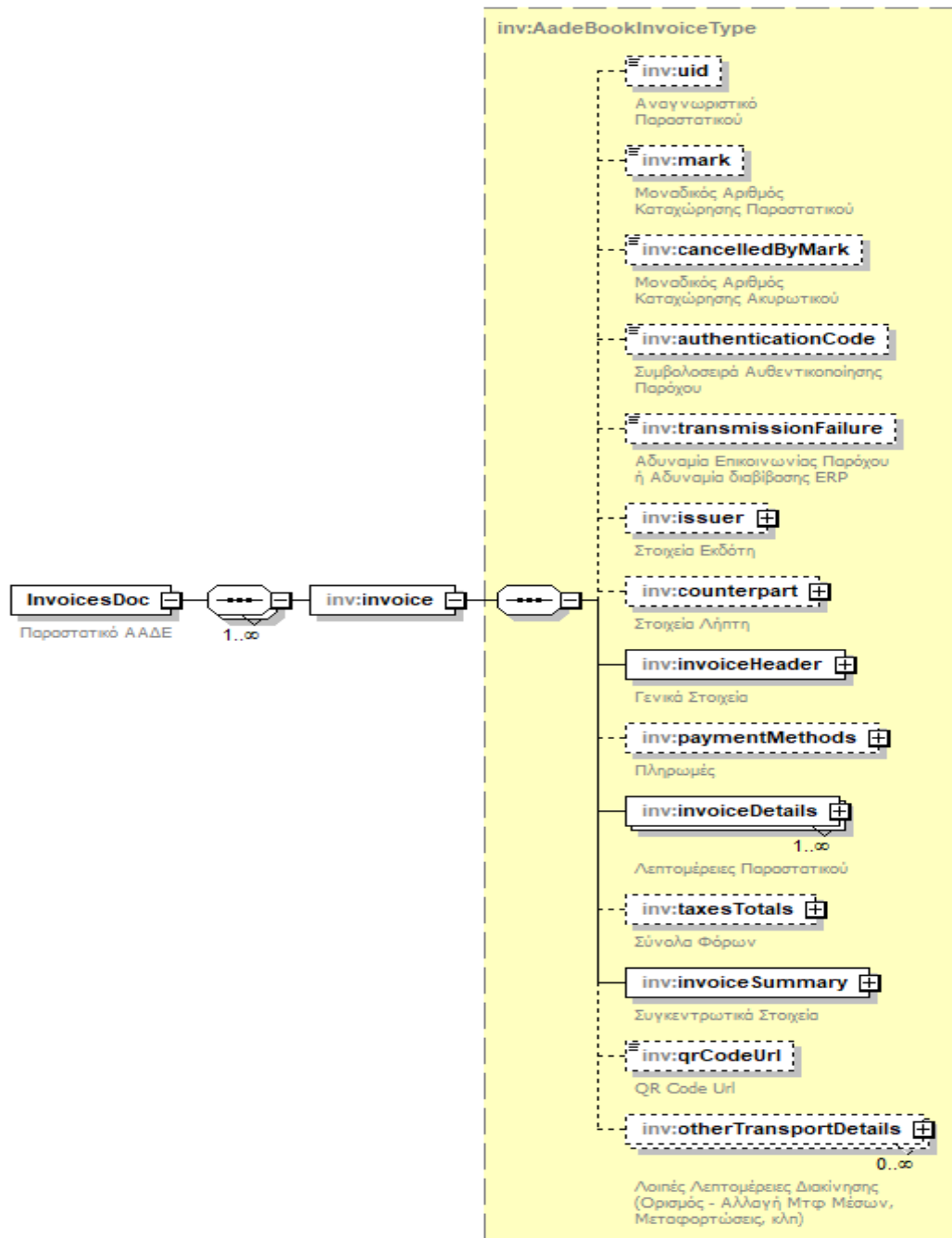

Field	Type	Mandatory	Description	Valid values
uid	xs:string	No	Invoice identifier	Length = 40 Filled in by the service
mark	xs:long	No	Unique Invoice Registration Number	Filled in by the service
cancelledByMark	xs:long	No	Unique Invoice Cancelation Number	Filled in by the service
authenticationCode	xs:string	No	Authentication Code	Filled in only by providers
transmissionFailure	xs:byte	Όχι	Inability to Provide Communication	Acceptable only in case of shipment by providers. Allowed values {1,2}: 1 : In case of inability of the entity to communicate with the provider during the issuance / deletion of a document 2 : In case of inability of the provider to communicate with myDATA during the issuance / transmission of a document
issuer	PartyType	No	Invoice issuer	
counterpart	PartyType	No	Invoice counterpart	
paymentMethods	PaymentMethodDetailType	No	Payment Methods	
invoiceHeader	InvoiceHeaderType	Yes	Invoice header	
invoiceDetails	InvoiceRowType	Yes	Invoice lines	
taxesTotals	TaxesType	No	Total taxes	
invoiceSummary	InvoiceSummaryType	Yes	Invoice Summary	
qrCodeUrl	xs:string	No	Encoded alphanumeric string to be used by programs for generating QR Codes of URL type.	Filled in by the Service (currently only for transfers via ERP at this stage)
otherTransportDetails	TransportDetailType	No	Other Shipment Details	

			(Definition-Change of transport means)	
--	--	--	--	--

## Remarks

- 1) Uid is the identifier of every invoice and is filled in by the service. It is calculated by the SHA-1 hash of 6 fields of the document which are:
  - Issuer's VAT number
  - Date of issue
  - Branch number in Taxis Registry
  - Invoice Type
  - Series
  - Serial Number (AA)ISO-8859-7 encoding is used when using the SHA-1 algorithm
- 2) Field mark is the Unique Invoice Registration Number
- 3) Field taxesTotals contains all taxes except VAT, which concern the whole document as a whole. If user uses this element, taxes will not insert except VAT on each line of the document separately.
- 4) Complex types PartyType, PaymentMethodDetailType, InvoiceHeaderType, InvoiceRowType, TaxTotalsType and InvoiceSummaryType are described later in this section.
- 5) Unique Invoice Cancellation Number exists only when the invoice has been cancelled and contains the cancellation MARK.
- 6) The authenticationCode is the authentication string of each document and is filled by the Service in case the shipment is made through a Electronic Invoicing Provider. It is calculated by the SHA-1 hash of 6 fields of the document which are:
  - Issuer's VAT number
  - Date of issue
  - Branch number in Taxis Registry
  - Invoice Type
  - Series
  - Serial Number (AA)
  - MARK
  - Total Invoice Value
  - Total VAT Invoice Value
  - Counterpart's VAT number
- 7) The field qrCodeUrl contains a URL with an encoded query string, intended to be used by applications for generating/importing QR Codes of URL type on documents. When read, the QR Code will lead to a page of the Service for reviewing the document.
- 8) The field otherTransportDetails (Other Shipment Details) is a list of type TransportDetailType.
- 9) The structure of otherTransportDetails is described below.

## 5.1 Party

The issuer and the counterpart are elements of type PartyType.

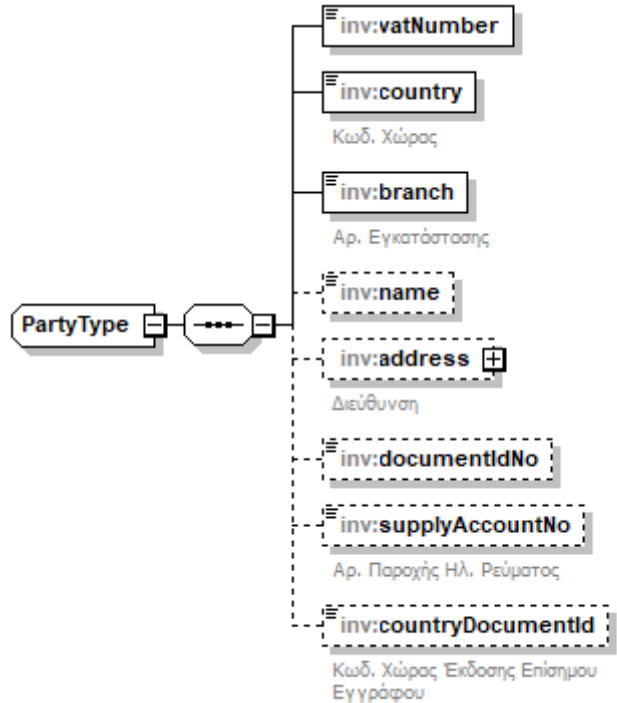

Field	Type	Mandatory	Description	Valid values
vatNumber	xs:string	Yes	VAT number	Any valid VAT number
Country	xs:string	Yes	Country code	Country codes
Branch	xs:int	Yes	Branch number	Min value = 0
Name	xs:string	No	Name	
Address	AddressType	No	Address	
documentIdNo	xs:string	No	Official document number	Maximum permissible length 100. Valid only in case of tax free document (specialInvoiceCategory = 4)
supplyAccountNo	xs:string	No	Electricity supply number	Maximum permissible length 100. Valid only in the case of fuel vouchers
countryDocumentId	xs:string	No	Country Code of Issuing Official Document	Country Codes

## Remarks

- 1) The country code is two characters and comes from the corresponding country list as described in ISO 3166.
- 2) If the branch is headquarters or doesn't exist, the branch field must have a value of 0.
- 3) For the issuer fields name and address are valid only in case the entity is not from Greece. For the counterpart field name must not be submitted if the entity is from Greece.
- 4) The official document number is allowed only in case of transmission of vouchers belonging to the special category of Tax free vouchers (the field of the header of the voucher `specialInvoiceCategory` has the value 4), and can be any official identification document (e.g. passport number) of the recipient of the voucher.
- 5) The number of Provision El. 5.5. The Electricity Supply Number is allowed only in case of transmission of fuel vouchers (the field of the `fuelInvoice` header has the value true - acceptable only for transmission by providers) and is information of the recipient of the voucher.
- 6) The country code of issuance of the official document (e.g., passport) is allowed only in the case of transferring documents that belong to the Special Document Category Tax free (the header field of the document `specialInvoiceCategory` has the value 4) and provided that the field of the official document number (`documentIdNo`) has been completed and concerns the recipient of the document.



## 5.1.1 Address

The address of the issuer (or the counterpart) is an element of type AddressType.

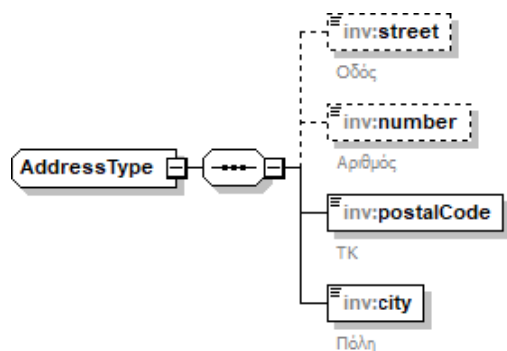

Field	Type	Mandatory	Description
street	xs:string	No	Streer
number	xs:string	No	Number
postalCode	xs:string	Yes	Postal code
city	xs:string	Yes	City

## 5.2 Payment Method

Payment method is an element of type PaymentMethodDetailType.

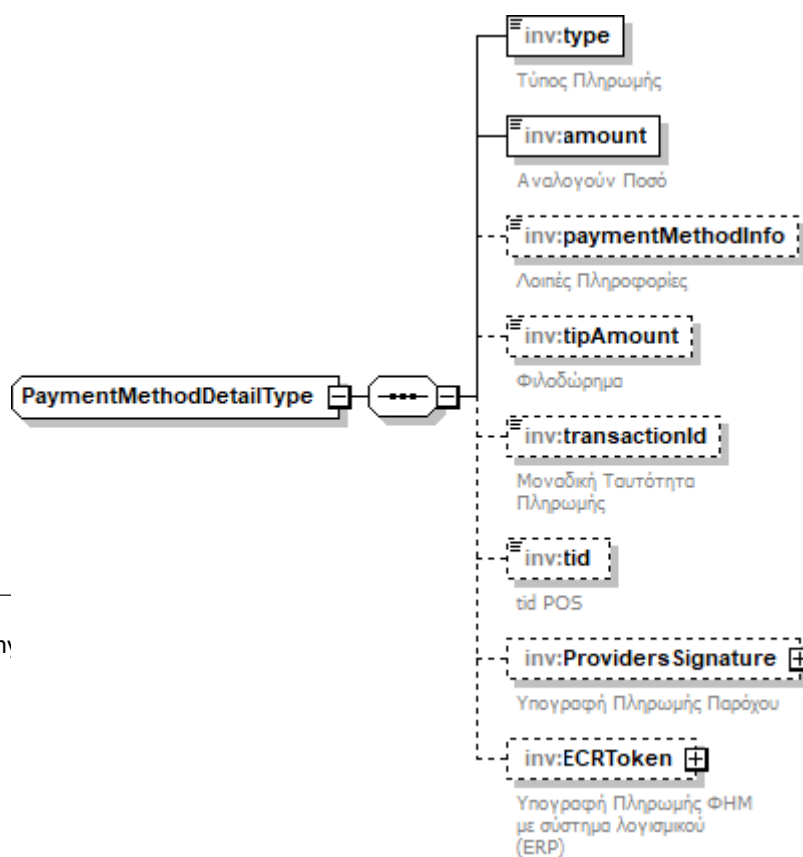

Field	Type	Mandatory	Description	Valid values
type	xs:int	Yes	Payment method	Min value = 1 Max value= 9
amount	xs:decimal	Yes	Amount	Min value = 0 Decimal digits = 2
paymentMethodInfo	xs:string	No	Information	
tipAmount	xs:decimal	No	Amount of Gratuity	Min value= 0 Decimal digits = 2
transactionId	xs:string	No	Unique Payment Identifier	
tid	xs:string	No	Code tid POS	Maximum allowed length 200
ProvidersSignature	ProviderSignatureType	No	Provider Payment Signature	
ECRToken	ECRTokenType	No	Payment Signature FHM with ERP Software System	

#### Remarks

- 1) Possible values of field type are described in the appendix
- 2) Field amount may refer to fraction of the invoice's total value
- 3) Field paymentMethodInfo contains additional information for the specified type
- 4) The field transactionId is transmitted in the case of payments with type = 7
- 5) The field ProvidersSignature is of type ProviderSignatureType, which is described in the following paragraph, and it is transmitted in the case of payments with type = 7 and when the transmission is done through the provider's channel
- 6) The field ECRToken is of type ECRTokenType, which is described in the following paragraph, and it is transmitted in the case of payments with type = 7 and when the transmission is done through ERP
- 7) The field tid is the tid of the POS

## 5.2.1 Provider Payment Signature

The field ProvidersSignature is an element of type ProviderSignatureType, and its structure is described below:

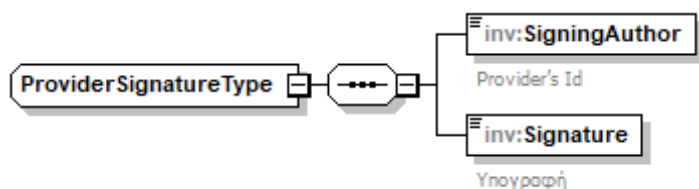

Field	Type	Mandatory	Description	Remarks
SigningAuthor	xs:string	Yes	Approval Decision Number by the Hellenic Public Accounting Office for Providers	Maximum allowed length: 20
Signature	xs:string	Yes	Signature	Details according to decision No. A. 1155/09-10-2023 (Government Gazette 5992 B/13.10.2023), as currently in force.

## 5.2.2 Payment Signature by the Public Finance Management System (PFMS) using Enterprise Resource Planning (ERP) software

The field ECRToken is an element of type ECRTokenType, and its structure is described below:

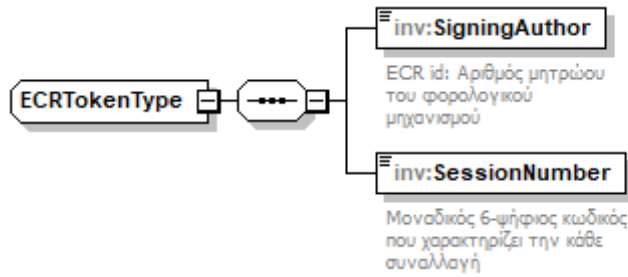

Field	Type	Mandatory	Description	Remarks
SigningAuthor	xs:string	Yes	ECR id Tax Mechanism Registry Number	Maximum allowed length: 20
Signature	xs:string	Yes	Signature	Details regarding decision No. A. 1155/09-10- 2023 (Government Gazette 5992 B/13.10.2023), as currently in effect.

### 5.3 Invoice header

The invoice's header is an InvoiceHeaderType element and its structure is described here:

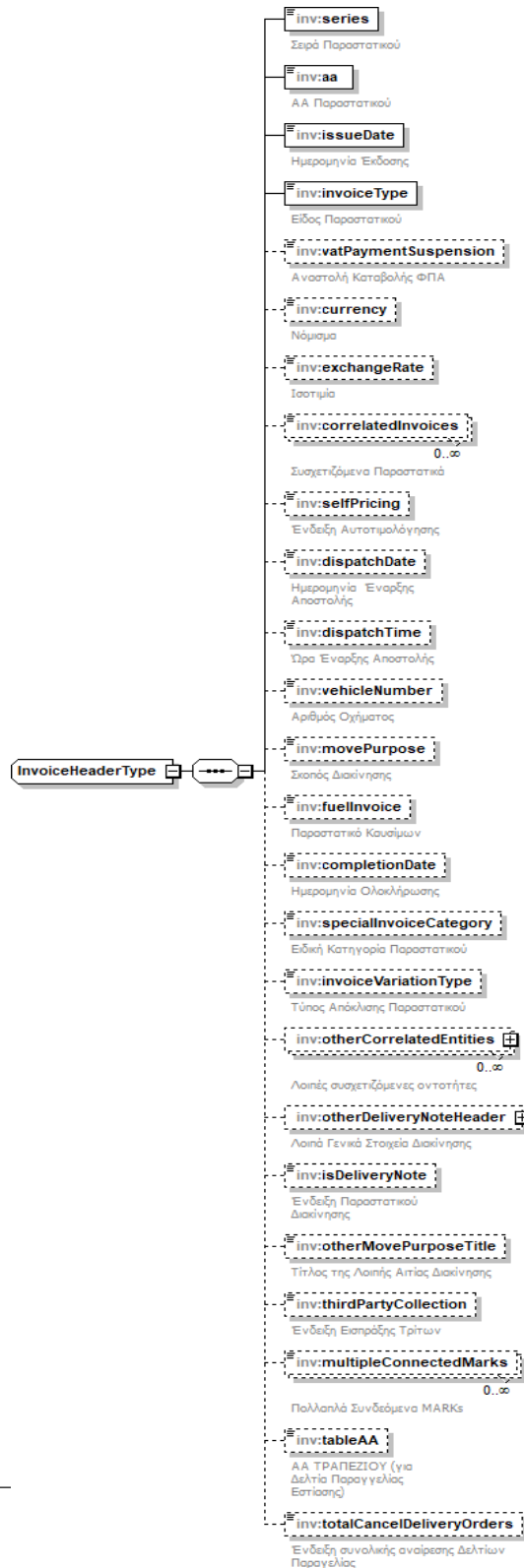

Field	Type	Mandatory	Description	Valid values
series	xs:string	Yes	Invoice series	Maximum length 50
aa	xs:string	Yes	Invoice's serial number	Maximum length 50
issueDate	xs:date	Yes	Invoice's issue date	
invoiceType	xs:string	Yes	Invoice type	1.1, 1.2, 1.3, 1.4, 1.5, 1.6, 2.1, 2.2,2.3, 2.4, 3.1, 3.2, 4, 5.1, 5.2, 6.1, 6.2, 7.1, 8.1, 8.2, 11.1, 11.2, 11.3, 11.4, 11.5, 12, 13.1, 13.2, 13.3, 13.4, 13.30, 13.31, 14.1, 14.2, 14.3, 14.4, 14.5, 14.30, 14.31, 15.1, 16.1, 17.1, 17.2, 17.3, 17.4, 17.5, 17.6. <b>[In the case of providers only the values 1.1 to 11.5 are available]</b>
vatPaymentSuspension	xs:boolean	No	VAT payment suspension	
currency	xs:string	No	Currency	Currency code
exchangeRate	xs:decimal	No	Exchange rate	Min value = 0 Decimal digits = 5
correlatedInvoices	xs:long	No	Correlated invoices	
selfPricing	xs:boolean	No	Self-billing indication	
dispatchDate	xs:date	No	Dispatch date	
dispatchTime	xs:time	No	Dispatch time	
vehicleNumber	xs:string	No	Vehicle number	
movePurpouse	xs:int	No	Purpose of movement	Min value = 1 Max value = 8
fuelInvoice	xs:boolean	No	Fuel Invoice (indication)	Acceptable only in the case shipping by providers.
specialInvoiceCategory	xs:int	No	Special category of document	Min value = 1 Max value = 4
invoiceVariationType	xs:int	No	Type of Deviation (Differentiation) Document	Min value = 1 Max value = 4 (Not allowed in case of shipping via providers)
otherCorrelatedEntities	EntityType	No	Other related entities	
otherDeliveryNoteHeader	OtherDeliveryNoteHeaderType	No	Additional General Delivery Information	

isDeliveryNote	xs:boolean	No	Document Delivery Indicator	
otherMovePurposeTitle	xs:string	No	Title of Other Delivery Reason	Accepted only in case movePurpose = 19 (Other Movements)
thirdPartyCollection	xs:boolean	No	Indication of Third-Party Receipt	Accepted only for document types 8.4 and 8.5
multipleConnectedMarks	xs:long	No	Multiple Connected Marks	Is not acceptable for documents of type 1.6,2.4 and 5.1
tableAA	xs:string	Yes	Table ID	Acceptable only for documents 8.6 – Maximum allowed length 50
totalCancelDeliveryOrders	xs:Boolean	No	Indicator of total cancellation of Order Slips	Acceptable only for documents 8.6

## Remarks

- 1) The exchangeRate field is the currency exchange rate against euro. It should be completed only when the currency is not EUR.
- 2) The currency code is derived from the corresponding list in accordance with ISO4217.
- 3) The correlatedInvoices element is a list of strings containing the associated invoices identifiers
- 4) In case of non-issuance of series of an invoice, the series field must have a value of 0
- 5) The selfPricing field specifies if it is self-billing invoice
- 6) The possible values of fields movePurpose and invoiceType are described in detail in the corresponding tables in the Appendix
- 7) The fuellInvoice field specifies whether it is a liquid fuel sales invoice and shipping is only allowed in the case of providers.
- 8) The possible values of the specialInvoiceCategory field are described in detail in the corresponding table of the Appendix
- 9) The possible values of the invoiceVariationType field are described in detail in the corresponding table in the Annex. Also details on how to use them from an operational point of view are described in the relevant operational document.
- 10) The field otherCorrelatedEntities represents a list of type EntityType
- 11) The structure of the type otherCorrelatedEntities is described below
- 12) The structure of the otherDeliveryNoteHeader type is described below
- 13) The field isDeliveryNote determines whether the document is both an invoice and a delivery note (e.g., for document type 1.1 - Sales Invoice, if the indicator isDeliveryNote = true, then it is also a delivery note, and additional circulation details should be provided)

- 14) The field otherMovePurposeTitle is completed when movePurpose = 19 (Other Movements) is selected, defining the title of the other circulation
- 15) The field thirdPartyCollection specifies whether the business utilizing Payment Instruments as a Payment Service User collects on behalf of third parties (case of document 8.4 - POS Collection Receipt) or returns transaction amounts for third parties (case of document 8.5 - POS Refund Receipt)
- 16) The field multipleConnectedMarks is a list that contains multiple connected MARKs (e.g., it can be used when issuing an invoice/receipt for multiple restaurant order slips).
- 17) The field totalCancelDeliveryOrders is valid only for documents of type 8.6 (restaurant order slip) and indicates whether the document fully cancels the MARKs of the restaurant order slips declared in the field multipleConnectedMarks (in this case, the MARKs of the restaurant order slips – type 8.6 – that are to be fully canceled must be declared in the field multipleConnectedMarks). In this case, the document must be submitted with a single line with zero values and VAT category 8 (Entries without VAT).

### 5.3.1 Other Correlated Entities

Other correlated entities are elements of type EntityType, and their structure is described below:

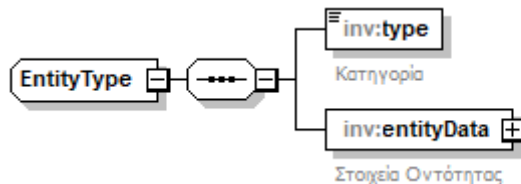

Field	Type	Mandatory	Description	Valid Values
type	xs:int	Yes	Entity Category	Appendix Table
entityData	PartyType	Yes	Entity (Individual) Details	

### 5.3.2 Other General Delivery Details



The Other General Delivery Details are of type OtherDeliveryNoteHeaderType, and their structure is described below:

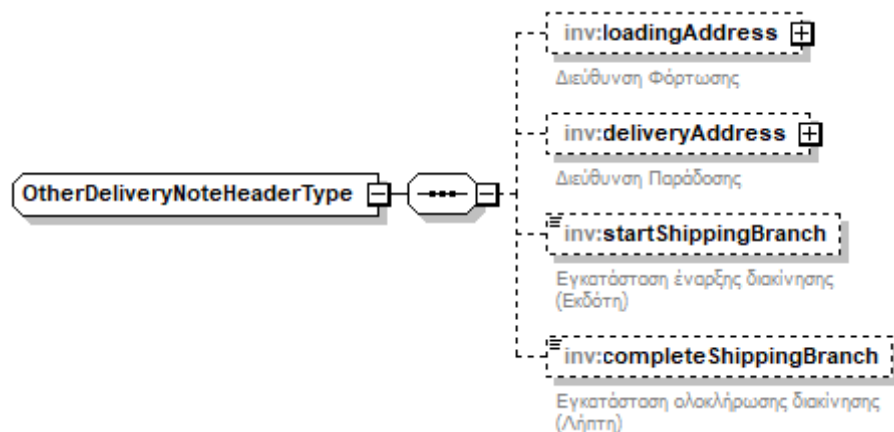

Field	Type	Mandatory	Description	Valid Values
loadingAddress	AddressType	Yes	Loading Address	It is completed for documents that are delivery notes (e.g., 9.3) or invoices and delivery notes (isDeliveryNote = true)
deliveryAddress	AddressType	Yes	Delivery Address	It is completed for documents that are delivery notes (e.g., 9.3) or invoices and delivery notes (isDeliveryNote = true)
startShippingBranch	xs:int	No	Dispatching Start Location (Issuer)	It is completed for documents that are delivery notes (e.g., 9.3) or invoices and delivery notes (if isDeliveryNote = true)
completeShippingBranch	xs:int	No	Receiving End Location (Recipient)	It is completed for documents that are delivery notes (e.g., 9.3) or

				invoices and delivery notes (if isDeliveryNote = true)
--	--	--	--	--

Remarks:

1. The field loadingAddress is of type AddressType, which type is elaborated in a previous corresponding paragraph (Entity Address)
2. The field deliveryAddress is of type AddressType, which type is elaborated in a previous corresponding paragraph (Entity Address)
3. The field startShippingBranch specifies the branch from which the circulation begins, in case the circulation starts from a branch (installation) of the issuer of the document, which is different from the issuer's branch for the delivery note
4. The field completeShippingBranch specifies the branch where the circulation will be completed, in case the circulation will be completed at a branch (installation) of the recipient of the document, which is different from the recipient's branch for the delivery note

## 5.4 Invoice details

Invoice's details (InvoiceDetails) are composed of one or more InvoiceRowType records.

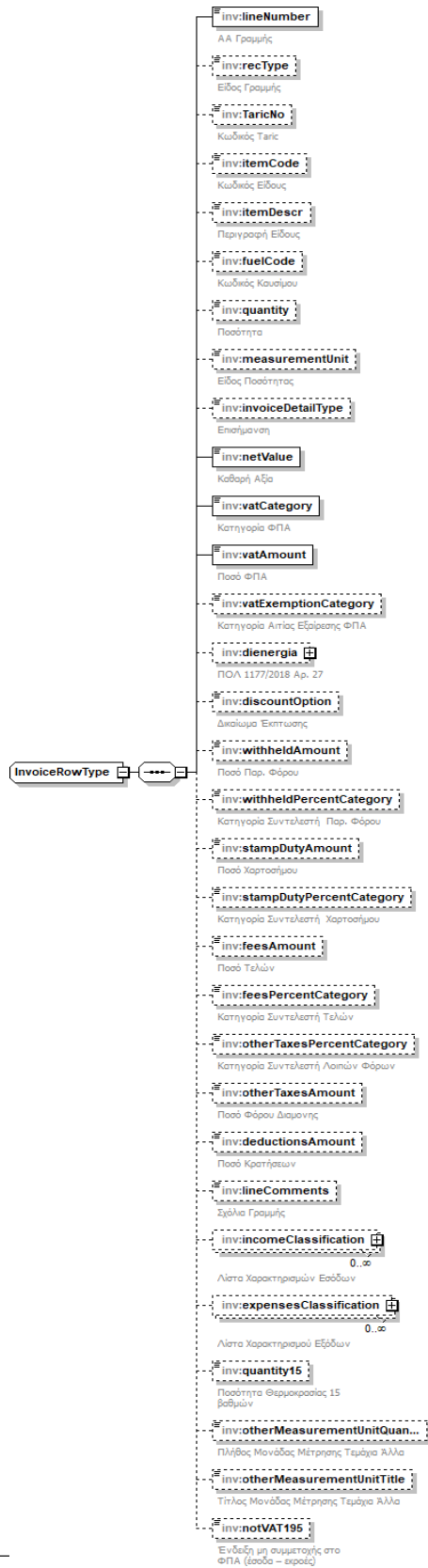

Field	Type	Mandatory	Description	Valid values
lineNumber	xs:int	Yes	Line number	Min value = 1
recType	xs:int	No	Line Type	Minimum value = 1 Maximum value = 7 Note: In this version the values 1, 4 and 5 can not be used - they are reserved in the model for future use
fuelCode	FuelCodes	No	Fuel Code	Fuel Codes (Price list - detailed prices in the respective Appendix) Acceptable only in cases of shipment by providers and in case the invoice is fuel invoice
quantity	xs:decimal	No	Quantity	Min value = 0
measurementUnit	xs:int	No	Unit of quantity	Value list: 1,2,3
invoiceDetailType	xs:int	No	Self-billing remark	Value list: 1,2
netValue	xs:decimal	Yes	Net value	Min value = 0 Decimal digits = 2
vatCategory	xs:int	Yes	VAT category	Min value = 1 Max value = 8
vatAmount	xs:decimal	Yes	VAT amount	Min value = 0 Decimal digits = 2
vatExemptionCategory	xs:int	No	VAT exemption category	Min value = 1 Max value = 23
dienergia	ShipType	No	Article 27 of POL 1177/2018	
discountOption	xs:boolean	No	Discount option	False / True
withheldAmount	xs:decimal	No	Withholding tax amount	Min value = 0 Decimal digits = 2
withheldPercentCategory	xs:int	No	Withholding tax rate category	Min value = 1 Max value = 15
stampDutyAmount	xs: decimal	No	Stamp duty amount	Min value = 0 Decimal digits = 2
stampDutyPercentCategory	xs:int	No	Stamp duty rate category	Value list: 1, 2, 3
feesAmount	xs:decimal	No	Fees amount	Min value = 0 Decimal digits = 2
feesPercentCategory	xs:int	No	Fees rate category	Min value = 1 Max value = 9
otherTaxesPercentCategory	xs:int	No	Other taxes rate category	Min value = 1 Max value = 14

otherTaxesAmount	xs:decimal	No	Other taxes amount	Min value = 0 Decimal digits = 2
deductionsAmount	xs:decimal	No	Deductions amount	Min value = 0 Decimal digits = 2
lineComments	xs:string	No	Line comments	
incomeClassification	IncomeClassificationType	No	Income classification	
expensesClassification	ExpensesClassificationType	No	Expenses classification	
quantity15	xs:decimal	No	Temperature quantity 15 degrees	Minimum value = 0. <u>Acceptable only in the case of dispatch by providers and where the document is a fuel document</u>
itemDescr	xs:string	No	Description of Species	Maximum permissible length 300. <u>Acceptable only in the case of special category tax free documents</u>
TaricNo	xs:string	No	Taric Code	Mandatory length: 10. Accepted only for documents that are invoices and delivery notes or simple delivery notes (e.g., 9.3)
itemCode	xs:string	No	Item Code	Mandatory length: 10. Accepted only for documents that are invoices and delivery notes or simple delivery notes (e.g., 9.3)
otherMeasurementUnitQuantity	xs:int	No	Quantity: Pieces (Other Measurement Unit)	Accepted only in case measurementUnit = 7 (Pieces_Other Cases)
otherMeasurementUnitTitle	xs:string	No	Quantity: Pieces (Other Measurement Unit)	Accepted only in case measurementUnit = 7 (Pieces_Other Cases)
notVAT195	xs:boolean	No	Indicator of non- participation in VAT (income – outputs)	Acceptable only for income documents between types 1.1 – 11.5

#### Remarks

- 1) The possible values for the measurementUnit, invoiceDetailType, vatCategory, vatExemptionCategory, withheldPercentCategory, stampDutyPercentCategory,

feesPercentCategory and otherTaxesPercentCategory fields are described in detail in the corresponding tables in the Appendix

- 2) Fields withheldAmount, feesAmount, otherTaxesAmount are filled in when the corresponding tax exists (even if it is percentage)
- 3) The vatExemptionCategory field is required if the vatCategory indicates a 0% VAT rate
- 4) For cases where VAT is not applied, the vatCategory field will have the value of 8
- 5) Line comments are filled in by the user and are used for information purposes only
- 6) Classifications (income if submitter is issuer, expenses if counterpart) must be submitted with the invoice in the corresponding fields incomeClassification – expensesClassification.
- 7) a) In case of sending lines with recType = 2 (end line with VAT) and / or recType = 3 (Line of Other Taxes with VAT), at the same time, if desired, the sending of withholdings/ fees / other taxes / stamp / reservations will be allowed at the level of invoice and not necessarily per line of invoice. In the case of these lines, the amounts corresponding to VAT charges (recType = 2) or other taxes (recType = 3) respectively, will be sent in the net value field of the line (netValue), while the corresponding fields amount fee (feesAmount) or amount of other taxes (otherTaxesAmount) will not be filled. Also on these lines it is not allowed to send other types of taxes / fees / reservations / stamp (eg on a line with recType = 2 in the same line are not allowed to send other taxes / reservations / withholdings/ stamp).  
  
b) The transmission with recType = 7 (negative sign of values) is only allowed in case of transmission of documents 17.3, 17.4, 17.5 and 17.6 and in this way it is indicated that the values of the line are negative (in the corresponding fields of the values the values are written in their absolute/positive values). Note that the sums of the values in the InvoiceSummaryType will be transmitted as sums of the absolute values of the corresponding line values, regardless of whether or not there are lines with recType = 7.
- 8) The possible values for the fuelCode field are described in detail in the corresponding table in the Annex. It is only allowed to be sent in the case of providers and if it is a fuel document (invoiceHeaderType.fuelInvoice = true). The value 999 is used in case there is a need for invoicing and other charges in a document in addition to fuel. Only one line with this code is allowed per document and the net value of this line must be less than or equal to the sum of the net value of the other fuel codes in the document.
- 9) The fields otherMeasurementUnitQuantity and otherMeasurementUnitTitle are mandatory when measurementUnit = 7 (Pieces\_Other Cases) is selected. By choosing measurementUnit = 7 (Pieces\_Other Cases) as the unit of measurement for the cases of delivery documents, the possibility is given to convey the information of a measurement unit that is not included in any of the available values of the list. This can be done by providing a numerical representation of the quantity

(otherMeasurementUnitQuantity) corresponding to the packaging type and a brief

description of the packaging type in the verbal field (otherMeasurementUnitTitle), e.g., 3\_Pallets. It should be noted that the quantity field corresponds to the number of items delivered and not the number of packaging units

- 10) By filling in the indicator of the field notVAT195 (with the value true), the amounts of the document's lines do not participate in the VAT declaration (outputs). It is acceptable only for income documents of types between 1.1 – 11.5

### 5.4.1 Activity Undertaking Declaration (POL 1177/2018, Article 27)

Activity undertaking declaration is an element of type ShipType:

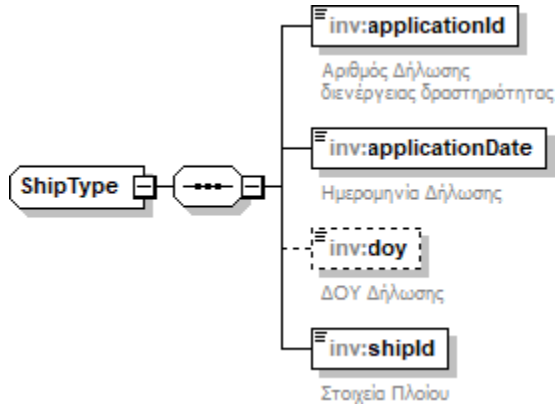

Field	Type	Mandatory	Description
applicationId	xs:string	Yes	Activity Undertaking Declaration Number
applicationDate	xs:date	Yes	Application date
doy	xs:string	No	Tax Return Filing DOY
shipID	xs:string	Yes	Ship details



## 5.5 Taxes totals

Element TaxTotalsType which contains the total taxes has the following structure:

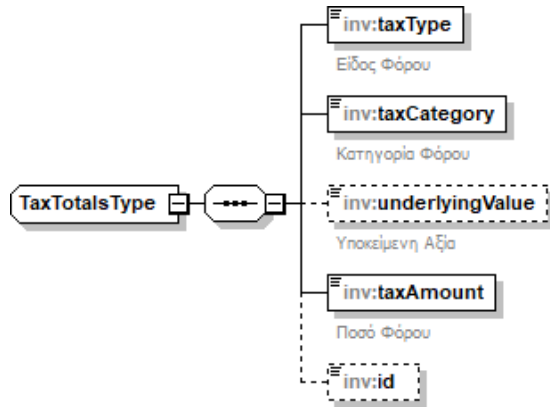

Field	Type	Mandatory	Description	Valid Values
taxType	xs:byte	Yes	Type of tax	1 = Withheld taxes 2 = Fees 3 = Other taxes 4 = Stamp duty 5 = Deductions
taxCategory	xs:byte	Yes	Tax category	Min value = 1
underlyingValue	xs:decimal	No	Underlying value to which the tax refers	Min value = 0 Decimal digits = 2
taxAmount	xs:decimal	Yes	Tax amount	Min value = 0 Decimal digits = 2
Id	xs:byte	No	Line number	

## 5.6 Invoice summary

The summary of the invoice is of type InvoiceSummaryType and is described below:

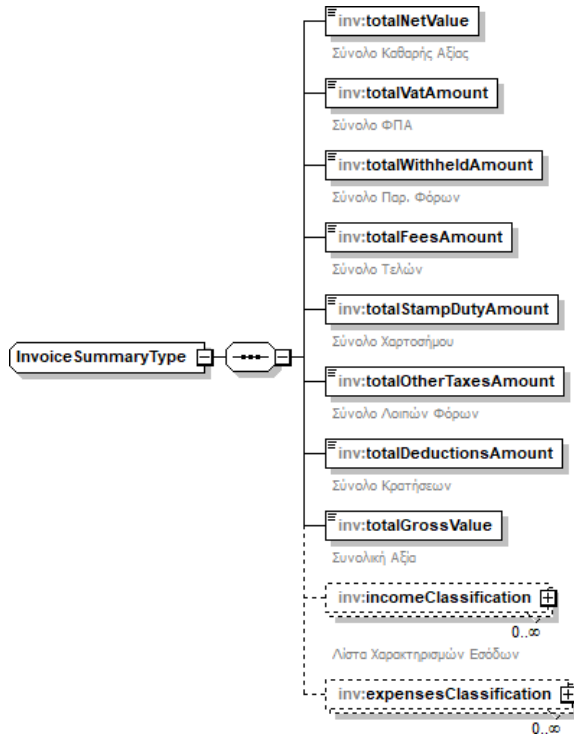

Field	Type	Mandatory	Description	Valid values
totalNetValue	xs:decimal	Yes	Total net value	Min value = 0 Decimal digits = 2
totalVatAmount	xs:decimal	Yes	Total VAT amount	Min value = 0 Decimal digits = 2
totalWithheldAmount	xs:decimal	Yes	Total withholding taxes amount	Min value = 0 Decimal digits = 2
totalFeesAmount	xs:decimal	Yes	Total fees amount	Min value = 0 Decimal digits = 2
totalStampDutyamount	xs:decimal	Yes	Total stamp duty amount	Min value = 0 Decimal digits = 2
totalOtherTaxesAmount	xs:decimal	Yes	Total other taxes amount	Min value = 0 Decimal digits = 2
totalDeductionsAmount	xs:decimal	Yes	Total deductions amount	Min value = 0 Decimal digits = 2
totalGrossValue	xs:decimal	Yes	Total gross value	Min value = 0 Decimal digits = 2
incomeClassification	IncomeClassificationType	No	Income classification	
expensesClassification	ExpensesClassificationType	No	Expenses classification	

## Remarks

- 8) Elements `incomeClassification` and `expensesClassification` contain the sums of all combinations of fields `classificationType` and `classificationCategory` that exist in the details of the invoice.
- 9) All taxes summary fields contain the summary of corresponding taxes of the details of the invoice or in the `taxesTotals` element.

## 5.7 Other Transport Means Information

The Other Transport Means Information (`otherTransportDetails`) consists of elements of type `TransportDetailType`, and its structure is described below:

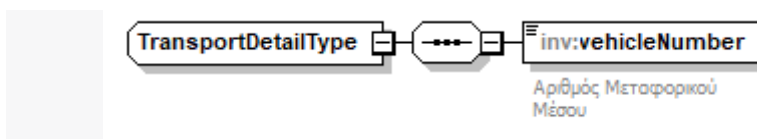

Field	Type	Mandatory	Description	Valid Values
vehicleNumber	xs:string	Yes	Transport Means Number	Maximum allowed length of 50.

## 5.8 Income classification

The `IncomeClassificationType` type (described below) is the basic structure of the Expense Characterization and is contained either in each line of the invoice separately (line characterization), or in the invoice summary (sum of characterizations by type - category), or in the `InvoiceIncomeClassificationType` object when revenue characterizations are submitted separately (see section 4.3.2)

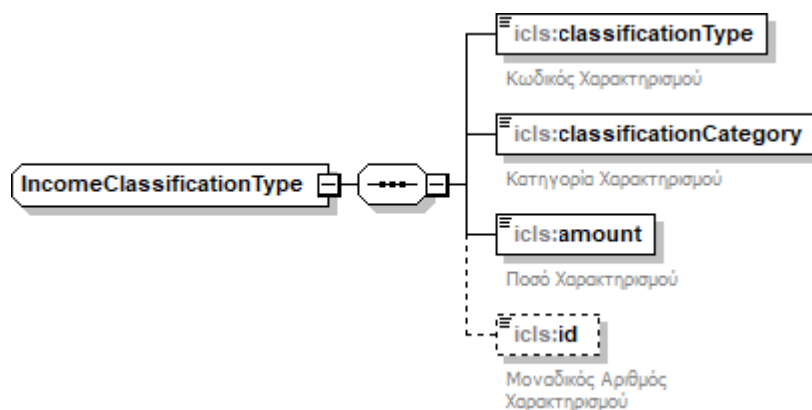

Field	Type	Mandatory	Description	Valid values
classificationType	xs:string	Yes	Classification type	E3_106, E3_205, E3_210, E3_305, E3_310, E3_318, E3_561_001, E3_561_002, E3_561_003, E3_561_004, E3_561_005, E3_561_006, E3_561_007, E3_562, E3_563, E3_564, E3_565, E3_566, E3_567, E3_568, E3_569, E3_570, E3_595, E3_596, E3_597, E3_880_001, E3_880_002, E3_880_003, E3_880_004, E3_881_001, E3_881_002, E3_881_003, E3_881_004
classificationCategory	xs:string	Yes	Classification category	category1_1, category1_2, category1_3, category1_4, category1_5, category1_6, category1_7, category1_8, category1_9, category1_10, category1_95
amount	xs:decimal	Yes	Amount	Min value = 0 Decimal digits = 2
id	xs:byte	No	Serial number of classification	

#### Remarks

- 1) Possible values of fields classificationType and classificationType are described in the appendix
- 2) Field id is used for serial numbering (1,2,3... κλπ) of the classifications of a row

## 5.9 Expenses classification

The ExpensesClassificationType type (described below) is the basic structure of the Expense Characterization and is contained either in each line of the invoice separately (line characterization), or in the invoice summary (sum of characterizations by type - category), or in the InvoiceExpensesClassificationType object when revenue characterizations are submitted separately (see section 4.3.3)

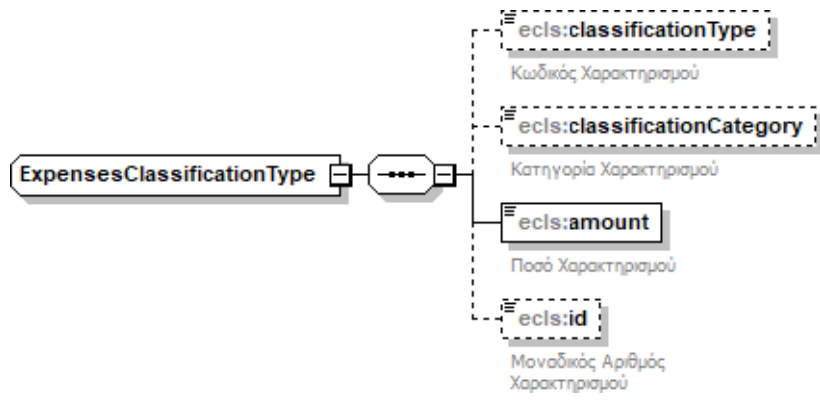

Field	Type	Mandatory	Description	Valid values
classificationType	xs: string	Yes	Classification type	E3_101,E3_102_001, E3_102_002 E3_102_003, E3_102_004, E3_102_005, E3_102_006,E3_104 E3_201, E3_202_001, E3_202_002 E3_202_003, E3_202_004, E3_202_005, E3_204, E3_207, E3_209, E3_301, E3_302_001, E3_302_002,E3_302_003, E3_302_004,E3_302_005, E3_304 E3_307, E3_309, E3_312, E3_313_001, E3_313_002, E3_313_003, E3_313_004, E3_313_005,E3_315,E3_581_001, E3_581_002,E3_581_003,E3_582 E3_583, E3_584,E3_585_001, E3_585_002,E3_585_003, E3_585_004,E3_585_005, E3_585_006,E3_585_007, E3_585_008,E3_585_009, E3_585_010, E3_585_011, E3_585_012,E3_585_013, E3_585_014,E3_585_015, E3_585_016,E3_586, E3_587, E3_588, E3_589, E3_590, E3_596, E3_597,E3_882_001, E3_882_002 E3_882_003, E3_882_004, E3_883_001, E3_883_002, E3_883_003, E3_883_004, VAT_361, VAT_362, VAT_363, VAT_364, VAT_365, VAT_366

classificationCategory	xs:string	Yes	Classification category	Value list: category2_1, category2_2, category2_3, category2_4, category2_5, category2_6, category2_7, category2_8, category2_9, category2_10, category2_11, category2_12, category2_13, category2_14, category2_95
amount	xs:decimal	Yes	Amount	Min value = 0 Decimal digits = 2
id	xs:byte	No	Serial number of classification	

#### Remarks

- 1) Possible values of fields classificationType and classificationType are described in the appendix
- 2) Field id is used for serial numbering (1,2,3... etc.) of the classifications of a row

## 6 Responses

### 6.1 Data submission

When the user uses a submission service (SendInvoices, SendIncomeClassification, SendExpensesClassification, CancelInvoice), he/she will receive a ResponseDoc object in xml

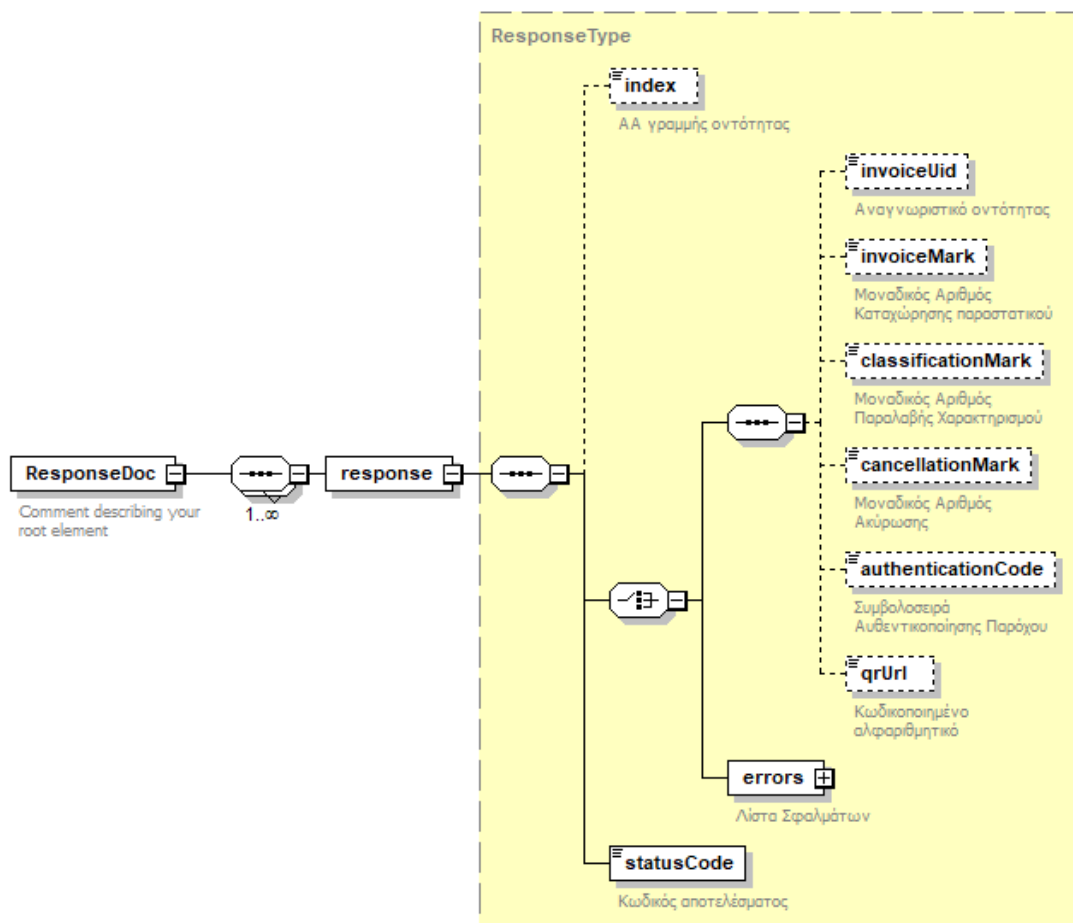

format. The object contains a list of response elements, one for each entity submitted.

Field	Type	Mandatory	Description	Values
Index	xs: int	No	Entity's line number inside the submitted xml	
statusCode	xs: string	Yes	Status code	Success, ValidationError, TechnicalError, XMLSyntaxError
invoiceUid	xs: string	No	Invoice identifier	Length =40
invoiceMark	xs: long	No	Unique Invoice Registration Number	



classificationMark	xs: long	No	Unique Classification Registration Number	
authenticationCode	xs:long	No	Authentication string	
CancellationMark	xs:long	No	Unique cancellation number	

qrUrl	xs: string	No	Encoded alphanumeric string	Used by programs for generating QR Codes of URL type.
Errors	ErrorType	Yes (choice)	Errors list	

**Remarks:**

1. The type of response (successful or failed procedure) is determined by the value of the statusCode field.
2. If successful, the statusCode field is set to Success and the response includes the corresponding values for the invoiceUid, invoiceMark, classificationMark and cancellationMark fields, depending on the entity submitted
3. In case of failure the statusCode field has a value corresponding to the type of error and the response contains a list of ErrorType error data for each entity whose submission failed. All error elements per entity are mandatory of the same category that characterises the response
4. The invoiceUid field returns only if the submission was for a document
5. The classificationMark field returns only in case the submission was about marking
6. The authenticationCode field returns if the submission was made through a provider
7. The cancellationMark field returns only if the submission was a cancellation of a document
8. The invoiceMark field contains the mark of the submitted invoice in case of submitted invoices and the mark of the invoice to which the submitted markings related, in case of submitted markings
9. The field qrUrl is returned only in document submissions of types from 1.1 to 11.5.

## 6.2 Data retrieval

When the user calls a data request service (*RequestDocs,RequestTransmittedDocs*), he/she will receive a RequestedDoc object in xml format. The object will include the list of requested invoices, classifications and cancellations which have bigger mark from the one given as parameter, as well as the continuationToken element (in cases where data exceeds the permissible limit and is retrieved partially).

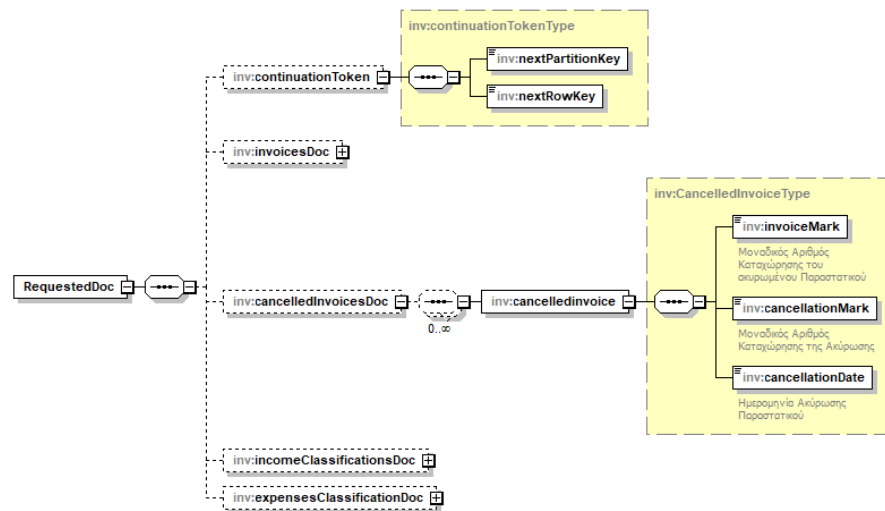

Field	Type	Mandatory	Description
continuationToken	continuationTokenType	No	Element for partial results retrieval
invoicesDoc	AadeBookInvoiceType	No	Invoices list
cancelledInvoicesDoc	CancelledInvoiceType	No	Cancelled invoices
invoiceMark	xs:long	Yes	Cancelled invoice's mark
cancellationMark	xs:long	Yes	Cancellation mark
cancellationDate	xs:date	Yes	Cancellation date
incomeClassificationsDoc	InvoiceIncomeClassificationType	No	Income classifications
expensesClassificationsDoc	InvoiceExpensesClassificationType	No	Expenses classifications
nextPartitionKey	xs:string	Yes	Parameter for next retrieval call
nextRowKey	xs:string	Yes	Parameter for next retrieval call

## Remarks

- 1) If a continuationToken is returned, the nextPartitionKey and nextRowKey fields will be filled in by the service and will be used in the next /RequestInvoices call the user will execute
- 2) Types AadeBookInvoiceType, InvoiceIncomeClassificationType και InvoiceExpensesClassificationType have been described in previous chapters

## 6.3 Receipt of Income - Expenses data

In cases where the user calls one of the two methods of obtaining income-expenses data (RequestMyIncome, RequestMyExpenses), as described in the previous paragraph, the user will receive a RequestedBookInfo object in xml format. The object will contain a list of income-expense data and document cancellations which have a mark greater than the one entered as a parameter, as well as the continuationToken element, in case the volume of data exceeds the allowed limit and the data is received in parts

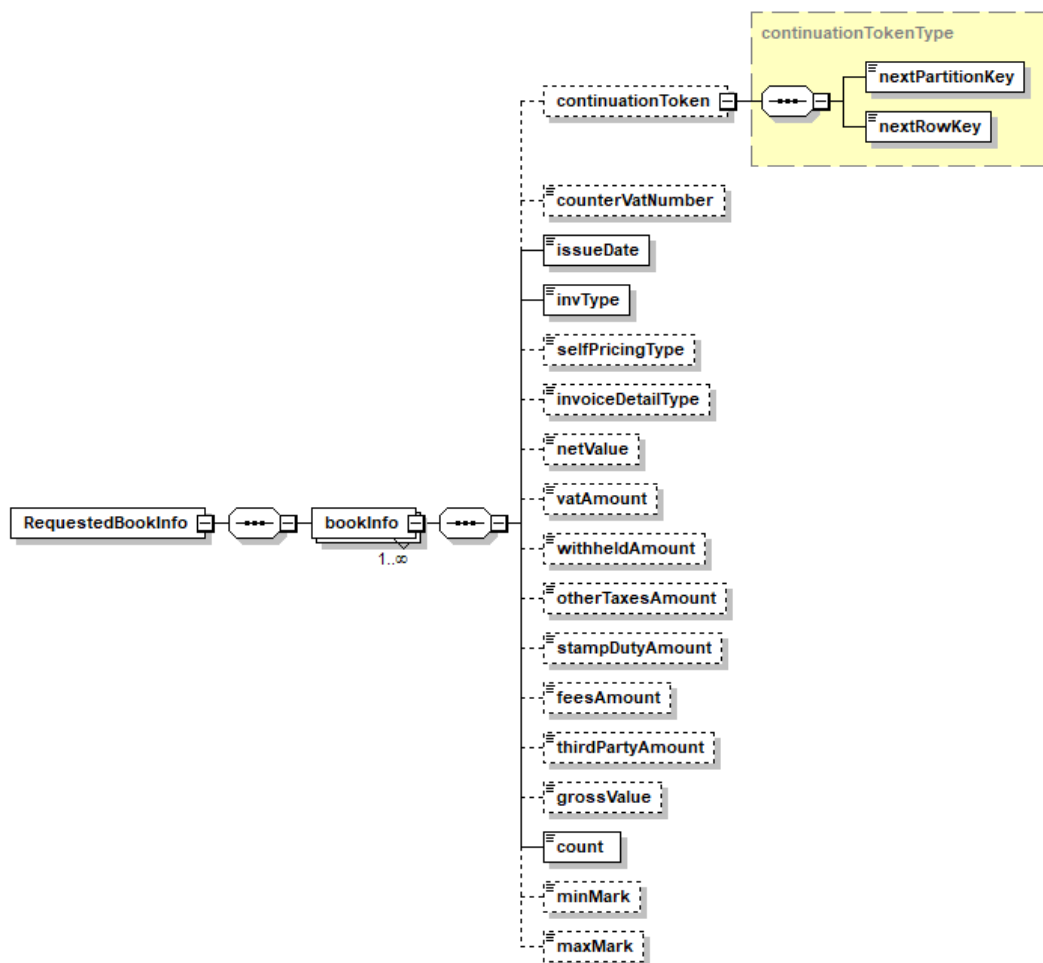

Field	Type	Mandatory	Description
continuationToken	continuationTokenType	No	Element for partial results retrieval
counterVatNumber	xs:string	No	VAT number of the recipient
issueDate	xs:date	Yes	Date of issue of the document
invType	xs:string	Yes	Type of document
selfpricing	xs:bool	No	Self-billing
invoiceDetailType	xs:int	No	Marking
netValue	xs:double	No	Net value
vatAmount	xs:double	No	VAT amount
withheldAmount	xs:double	No	Amount of tax withheld
otherTaxesAmount	xs:double	No	Amount Other taxes
stampDutyAmount	xs:double	No	Stamp Amount
feesAmount	xs:double	No	Amount of duties
deductionsAmount	xs:double	No	Deductions Amount
thirdPartyAmount	xs:double	No	Amount Third parties
grossValue	xs:double	No	Total Value
count	xs:int	Yes	Count
minMark	xs:string	No	Minimum Mark
maxMark	xs:string	No	Maximum Mark

Notes:

1. In case the continuationToken element is returned the nextPartitionKey and nextRowKey fields will be filled by the service and used in the next call of the same method called by the user
2. Each row corresponds to a unique set of values for the counterVatNumber, issueDate, invType and reference VAT fields

3. The minMark maxMark parameters correspond to the minimum and maximum mark that make up the set of documents corresponding to the specific line
4. Documents that have self-billing are retrieved on a different line, with the corresponding value in this field
5. The lines of documents 1.5 (Settlement - Third Party Fees) are recovered on different lines, with the corresponding value in this field

#### 6.4 Receiving VAT Information

In cases where the user calls the method to receive VAT information (RequestVatInfo), as described in the previous paragraph, they will receive a RequestedVatInfo object in XML format. The object will include a list of input and output elements per document (VatInfo) for the VAT number entered as a parameter, as well as the continuationToken element, in case the volume of data exceeds the permissible limit and retrieval is done in segments.

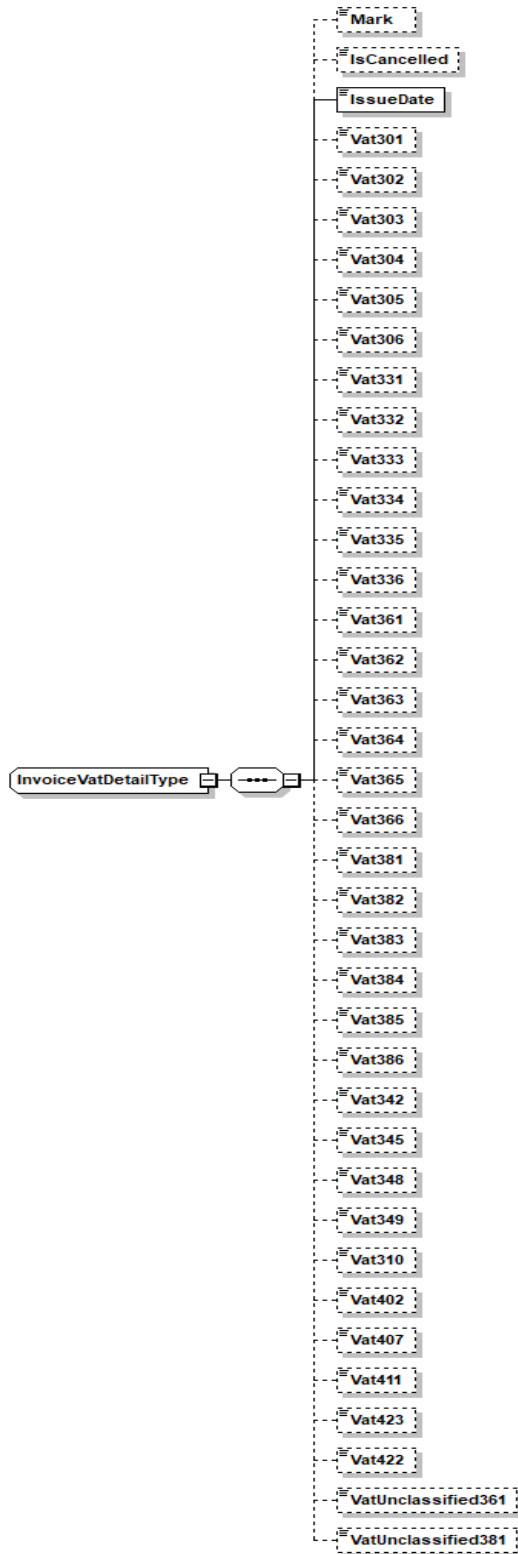

Field	Type	Mandatory	Description
continuationToken	continuationTokenType	No	Element for incremental retrieval of results
Mark	xs:string	No	The "MARK" of the document
IsCancelled	xs:boolean	No	If the document is canceled
IssueDate	xs:dateTime	Yes	The issuance date of the document
Vat301	xs:decimal	No	The VAT amount of the field 301
Vat302	xs:decimal	No	The VAT amount of the field 302
Vat303	xs:decimal	No	The VAT amount of the field 303
Vat304	xs:decimal	No	The VAT amount of the field 304
Vat305	xs:decimal	No	The VAT amount of the field 305
Vat306	xs:decimal	No	The VAT amount of the field 306
Vat331	xs:decimal	No	The VAT amount of the field 331
Vat332	xs:decimal	No	The VAT amount of the field 332
Vat333	xs:decimal	No	The VAT amount of the field 333
Vat334	xs:decimal	No	The VAT amount of the field 334
Vat335	xs:decimal	No	The VAT amount of the field 335
Vat336	xs:decimal	No	The VAT amount of the field 336
Vat361	xs:decimal	No	The VAT amount of the field 361
Vat362	xs:decimal	No	The VAT amount of the field 362
Vat363	xs:decimal	No	The VAT amount of the field 363
Vat364	xs:decimal	No	The VAT amount of the field 364
Vat365	xs:decimal	No	The VAT amount of the field 365
Vat366	xs:decimal	No	The VAT amount of the field 366
Vat381	xs:decimal	No	The VAT amount of the field 381
Vat382	xs:decimal	No	The VAT amount of the field 382
Vat383	xs:decimal	No	The VAT amount of the field 383
Vat384	xs:decimal	No	The VAT amount of the field 384
Vat385	xs:decimal	No	The VAT amount of the field 385
Vat386	xs:decimal	No	The VAT amount of the field 386
Vat342	xs:decimal	No	The VAT amount of the field 342
Vat345	xs:decimal	No	The VAT amount of the field 345
Vat348	xs:decimal	No	The VAT amount of the field 348
Vat349	xs:decimal	No	The VAT amount of the field 349
Vat310	xs:decimal	No	The VAT amount of the field 310
Vat402	xs:decimal	No	The VAT amount of the field 402
Vat407	xs:decimal	No	The VAT amount of the field 407
Vat411	xs:decimal	No	The VAT amount of the field 411
Vat423	xs:decimal	No	The VAT amount of the field 423
Vat422	xs:decimal	No	The VAT amount of the field 422
VatUnclassified361	xs:decimal	No	The VAT amount of the field 361 unclassified
VatUnclassified381	xs:decimal	No	The VAT amount of the field 381 unclassified

Remarks:

- Each field contains the VAT amount corresponding to the respective field in the VAT inflows-outflows table
- The "Mark" field is returned only when the results are per document and not per day



## 7 Errors

Errors are Error Type components and are described below:

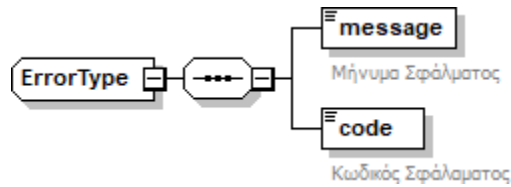

Every error element that concerns an entity consists of a message describing the error and an error code.

Field	Type	Mandatory	Description
message	xs: string	Yes	Error message
code	xs: string	Yes	Error code

### 7.1 Technical errors

Technical errors characterize the call as unsuccessful and return a typical .NET HttpResponseMessage instead of the ErrorType described in paragraph 7. Therefore they do not have a specific error code, are not accompanied by a statusCode of the ResponseType element, and are recognized by the corresponding HttpStatus.

#	HTTP Response	Description
1	HTTP 401 UNAUTHORIZED	Aade-user-id header is missing
2	HTTP 401 UNAUTHORIZED	Access Key does not correspond to given User Id
3	HTTP 400 BAD_REQUEST	Please pass mark in the request parameters or body
4	HTTP 400 BAD_REQUEST	General Exception Error

## 7.2 Operational errors

Operational errors are of the ErrorType type (see Par. 7) and occur when the operational tests fail. In their case the call is considered technically successful.

#	HTTP Response	statusCode	Code	Element	Description
1	HTTP 200 OK	XMLSyntaxError	101	Application	XML Syntax Validation Error
2	HTTP 200 OK	ValidationError	102	Application	Vat number {vatNumber} does not belong to active corporation
3	HTTP 200 OK	ValidationError	103	Application	Please pass mark in the request parameters
4	HTTP 200 OK	ValidationError	104	Application	Requested Invoice was not found
5	HTTP 200 OK	ValidationError	201	Invoice	Author VAT number is not the same with User VAT number
6	HTTP 200 OK	ValidationError	202	Invoice	Invalid Receiver VAT number
7	HTTP 200 OK	ValidationError	203	Invoice	Gross Value doesn't match with sum of net value plus taxes
9	HTTP 200 OK	ValidationError	204	Invoice	{Field} is mandatory for this invoice type
10	HTTP 200 OK	ValidationError	205	Invoice	{Field} is forbidden for this invoice type
11	HTTP 200 OK	Technical Error	206	Invoice	Unexpected technical error for invoice line
12	HTTP 200 OK	ValidationError	207	Invoice	The sum of net values of the invoice lines doesn't match with total net value of the invoice
13	HTTP 200 OK	ValidationError	208	Invoice	The sum of gross values of the invoice lines doesn't match with total gross value of the invoice
14	HTTP 200 OK	ValidationError	209	Invoice	The sum of vat amount of the invoice lines doesn't match with total vat amount of the invoice
15	HTTP 200 OK	ValidationError	210	Invoice	The sum of withheld amount of the invoice lines doesn't match with total withheld amount of the invoice
16	HTTP 200 OK	ValidationError	211	Invoice	Exchange Rate must be greater than 0 when the currency is not Euro
17	HTTP 200 OK	ValidationError	212	Invoice	AA element must be number (positive) for issuer from Greece
18	HTTP 200 OK	ValidationError	213	Invoice	{Field} must have value 0 for this invoice type
19	HTTP 200 OK	ValidationError	214	Invoice	Element {Element} must be sent only if it is true
20	HTTP 200 OK	ValidationError	215	Invoice	Vat category must have value 8 for this invoice type
21	HTTP 200 OK	ValidationError	216	Invoice	Vat category must have value other than 8 for this invoice type
22	HTTP 200 OK	ValidationError	217	Invoice	When vatCategory has value 7, element vatExemptionCategory is mandatory
23	HTTP 200 OK	ValidationError	218	Invoice	Vat Amount must have value 0 for this invoice type
24	HTTP 200 OK	ValidationError	219	Invoice	Issuer Name is forbidden for Issuer from Greece
25	HTTP 200 OK	ValidationError	220	Invoice	Counterpart Name is forbidden for Counterpart from Greece
26	HTTP 200 OK	ValidationError	221	Invoice	{Field} is forbidden for the lines that have invoiceDetailType = 2 for this invoice type
27	HTTP 200 OK	ValidationError	222	Invoice	{Field} must have value greater than 0 for this invoice

					type
28	HTTP 200 OK	ValidationError	223	Invoice	Unsupported invoice type
29	HTTP 200 OK	ValidationError	224	Invoice	Taxes are allowed either per invoice line or per invoice (not in both)
30	HTTP 200 OK	ValidationError	225	Invoice	{Field} must exist (cannot be null) since the {Field} is not null (invoice line {lineNumber})
31	HTTP 200 OK	ValidationError	226	Invoice	The sum of {field} amount of the invoice {section} doesn't match with total {field} amount of the invoice
31	HTTP 200 OK	ValidationError	227	Invoice	{Field1} cannot exist (must be null) since the {Field1} is null (invoice line : {lineNumber}) [ Possible {Field1, Field2} values: {'feesAmount', 'feesPercentCategory'}, {'stampDutyAmount', 'stampDutyPercentCategory'}, {'withheldAmount', 'withheldPercentCategory'}]
32	HTTP 200 OK	ValidationError	228	Invoice	{Field} is invalid [Possible {Field} values: {UID, InvoiceType} [concerns only the providers]
33	HTTP 200 OK	ValidationError	229	Invoice	{Field1} is not correct according to the given: {Field2} (invoice line: {lineNumber}) [ Possible {Field1, Field2} values: {'feesAmount', 'feesPercentCategory'}, {'stampDutyAmount', 'stampDutyPercentCategory'}, {'withheldAmount', 'withheldPercentCategory'}][concerns only the providers]
34	HTTP 200 OK	ValidationError	230	Invoice	{Field} is mandatory for invoice detail (number) [Possible {Field} values: {E3 classifications, VATclassifications}]
35	HTTP 200 OK	ValidationError	231	Invoice	{Field} is forbidden for invoice detail (number) [Possible {Field} values: {E3 classifications, VATclassifications}]
36	HTTP 200 OK	ValidationError	233	Invoice	UID: " + {uid} + " has already been sent [concerns only the providers]
37	HTTP 200 OK	ValidationError	234	Invoice	The values 7 or 8 are not allowed for Vat Category for this invoice type
38	HTTP 200 OK	ValidationError	235	Invoice	Issuer must be different from counterpart
39	HTTP 200 OK	ValidationError	236	Invoice	The Sender (vatnumber): " + {afm} + " must be different from the issuer (vatnumber)
40	HTTP 200 OK	ValidationError	237	Invoice	Underlying Value(s) of taxes cannot be greater than the total net value of invoice
41	HTTP 200 OK	ValidationError	239	Invoice	Taxamount(s) of taxes cannot be greater than the total net value of invoice

42	HTTP 200 OK	ValidationError	240	Invoice	240/ValidationError -Taxamount {Taxamount } of taxline: {A/A} cannot be greater than the corresponding underlying value
43	HTTP 200 OK	ValidationError	241	Invoice	241/ValidationError -{Field1} cannot be greater than the corresponding invoiceline net value (invoice line: {linenumber} ) [ Possible {Field1} values: , 'feesAmount', 'otherTaxesPercentAmount', 'stampDutyAmount, 'withheldAmount' ->
44	HTTP 200 OK	ValidationError	242	Invoice	242/ValidationError - {Field} 's country for this invoicetype must be Greece [Possible {Field} values: {Issuer, Counterpart}]
45	HTTP 200 OK	ValidationError	243	Invoice	243/ValidationError - {Field} 's country for this invoicetype must be in Europe but not Greece [Possible {Field} values: {Issuer, Counterpart}]
46	HTTP 200 OK	ValidationError	244	Invoice	244/ValidationError - {Field} 's country for this invoicetype must not be in EU [Possible {Field} values: {Issuer, Counterpart}]
47	HTTP 200 OK	ValidationError	245	Invoice	Provider is not authorised to issue Invoices for: {vatNumber}
48	HTTP 200 OK	ValidationError	246	Invoice	Invoice of type 1.5 must have at least one line with detailtype = 1 and one with detail type=2
49	HTTP 200 OK	ValidationError	247	Invoice	Invoice line: {lineNumber}. {Field} is forbidden. [Possible {Field} values: {recType=1, recType=4, recType=5}]
50	HTTP 200 OK	ValidationError	248	Invoice	Invoice with MARK {mark} cannot be cancelled because was not posted by VAT number {vat}
51	HTTP 200 OK	ValidationError	249	Invoice	Invoice with MARK {mark} cannot be cancelled because of being posted by provider
52	HTTP 200 OK	ValidationError	250	Invoice	Invoice with MARK {mark} cannot be cancelled because of being posted by myDATA Invoicing
53	HTTP 200 OK	ValidationError	251	Invoice	Invoice with MARK {mark} cannot be cancelled because of being already cancelled
54	HTTP 200 OK	ValidationError	252	Invoice	Record with MARK {mark} is not a valid Invoice
55	HTTP 200 OK	ValidationError	253	Invoice	IssueDate is invalid, it must be greater or equal than {date}and less or equal than current date * It does not concern the providers

56	HTTP 200 OK	ValidationError	254	Invoice	TaxLine (TaxTotals) : + {taxlinenumber} . {field} + fieldData} is forbidden
57	HTTP 200 OK	ValidationError	255	Invoice	Invoice with MARK {mark} cannot be cancelled because it is connected with active invoice with MARK {mark1}
58	HTTP 200 OK	ValidationError	256	Invoice	Invoice with MARK {mark} cannot be classified because of being already cancelled
59	HTTP 200 OK	ValidationError	257	Invoice	Invoice with MARK {mark} cannot be cancelled because of being posted by TaxRegister
60	HTTP 200 OK	ValidationError	258	Invoice	All invoice rows should have {Field} [Possible {Field} values: {recType=3}]
61	HTTP 200 OK	ValidationError	259	Invoice	Invoice cannot be posted because it replaces invoice with MARK {mark} having same UID and is still connected with active invoices
62	HTTP 200 OK	ValidationError	260	Invoice	IssueDate is invalid, it must be less or equal than current date
63	HTTP 200 OK	ValidationError	261	Invoice	Each Invoice row must have unique line number
64	HTTP 200 OK	ValidationError	262	Invoice	{field} length must be less or equal than {number}
65	HTTP 200 OK	ValidationError	263	Invoice	Invoice with invoiceVariationType {field} and IssueDate {issueDate} cannot be sent earlier than { date} [Possible {field} values: {invoiceVariationType=1,2,3,4}]
66	HTTP 200 OK	ValidationError	264	Invoice	Invoice with invoiceVariationType {field} cannot be sent for issueDate's year earlier than 2021 [Possible {field} values: {invoiceVariationType=1,2,3,4}]
67	HTTP 200 OK	ValidationError	265	Invoice	The maximum allowed number of invoices contained in one message is 5000
68	HTTP 200 OK	ValidationError	266	Invoice	{msg11} is forbidden {msg2} [Possible {msg1} values: {'Invoice with SpecialInvoiceCategoryType field with value 4 (taxfree invoice)'}] [Possible {msg2} values: {'for invoices sent by provider channel'}]
69	HTTP 200 OK	ValidationError	267	Invoice	{msg11} is allowed {msg2} [Possible {msg1} values: {'Invoice with SpecialInvoiceCategoryType field with value 4 (taxfree invoice)'}] [Possible {msg2} values: {'only for invoices sent by erp or timologio channel'}]
70	HTTP 200 OK	ValidationError	268	Invoice	In case of fuelInvoice, at least one line must have fuelCode different from 999
71	HTTP 200 OK	ValidationError	269	Invoice	In case of fuelInvoice, the net value of the invoice line with fuelCode 999 must be less or equal than sum of net values of the other invoice lines
72	HTTP 200 OK	ValidationError	270	Invoice	In case of fuelInvoice, only one line can have fuelCode equal with 999
73	HTTP 200 OK	ValidationError	271	Invoice	Invoice Line Number: {linenumber}. VatExemptionCategory field is used only in case of

					vatCategory = 7
74	HTTP 200 OK	ValidationError	272	Invoice	{field} is mandatory + {moreInfo} [ <i>{moreInfo} μπορεί να είναι null</i> ]
75	HTTP 200 OK	ValidationError	273	Invoice	{field} is not allowed + {moreInfo} [ <i>{moreInfo} μπορεί να είναι null</i> ]
76	HTTP 200 OK	ValidationError	274	Invoice	{field} are mandatory for this invoicetype + {moreInfo} [ <i>{moreInfo} μπορεί να είναι null</i> ]
77	HTTP 200 OK	ValidationError	275	Invoice	The message cannot contain invoices and invoices/consignment notes with the same uid
78	HTTP 200 OK	ValidationError	276	Invoice	{field} length must be equal with {number}
79	HTTP 200 OK	ValidationError	277	Invoice	The message cannot contain invoices of type: {invoiceType} with the same uid
80	HTTP 200 OK	ValidationError	278	Invoice	IssueDate is invalid, it must be greater or equal with current date
81	HTTP 200 OK	ValidationError	279	Invoice	Invoice with MARK {mark} cannot be cancelled + {moreInfo} [ <i>{moreInfo} μπορεί να είναι null</i> ]
82	HTTP 200 OK	ValidationError	280	Invoice	DispatchDate is invalid, it must be greater or equal with current date
83	HTTP 200 OK	ValidationError	301	Classification	Invoices with MAPK {mark} requested not found
84	HTTP 200 OK	ValidationError	302	Classification	Duplicate classification line number {lineNumber}
85	HTTP 200 OK	ValidationError	303	Classification	Line number {lineNumber} not found in invoice with MARK
86	HTTP 200 OK	ValidationError	304	Classification	All invoice rows or none should have classifications included
87	HTTP 200 OK	ValidationError	305	Classification	Invoice line: {lineNumber}. Duplicate classification type {classificationType} and category{classificationCategory}
88	HTTP 200 OK	ValidationError	306	Classification	Invoice line: {lineNumber}. Sum of classifications are not equal to line's net value
89	HTTP 200 OK	ValidationError	307	Classification	Classification type {classificationType} is forbidden for Classification category {classificationCategory}
90	HTTP 200 OK	ValidationError	308	Classification	Classification category {classificationCategory} is forbidden for Invoice type {classificationType}
91	HTTP 200 OK	ValidationError	309	Classification	Classifications are forbidden for Invoice type {invoiceType}
92	HTTP 200 OK	TechnicalError	310	Classification	All classifications of invoice or none should have category value category2_4
93	HTTP 200 OK	ValidationError	311	Classification	Classification with type {classificationType} and category " {classificationCategory} not found in invoice summary

94	HTTP 200 OK	ValidationError	312	Classification	Sum of classifications with type {classificationType} and category {classificationCategory} not matching with related total in invoice summary
95	HTTP 200 OK	ValidationError	313	Classification	Classification type {classificationType} is forbidden for Classification category {classificationCategory} combined with invoice type {invoiceType}
96	HTTP 200 OK	ValidationError	314	Classification	All invoices should contain either income or expenses classifications section, not both or none
97	HTTP 200 OK	ValidationError	315	Classification	VAT classifications have no category
98	HTTP 200 OK	ValidationError	316	Classification	VAT classifications are not allowed in case of VATexemption
99	HTTP 200 OK	ValidationError	317	Classification	Invoice detail { lineNumber } : VAT classification must be of type 366 in case vatExemptionCategory = 16
100	HTTP 200 OK	ValidationError	318	Invoice	Element {Field} must have same value with correlated's one
101	HTTP 200 OK	ValidationError	319	Invoice	Net value of correlated invoice already exceeded by sum of net values of invoices correlated to it
102	HTTP 200 OK	TechnicalError	320	Classification	Unexpected technical error for classification line
103	HTTP 200 OK	ValidationError	321	Classification	Classifications are not allowed only in the invoice summary
104	HTTP 200 OK	ValidationError	322	Invoice	Unsupported correlated invoice type
105	HTTP 200 OK	ValidationError	323	Classification	User cannot use directly this service due to annual gross income limits
106	HTTP 200 OK	ValidationError	324	Classification	Classification rejection or deviation is not allowed to be sent with this method
107	HTTP 200 OK	TechnicalError	330	Classification	Unexpected technical error for classification line
108	HTTP 200 OK	TechnicalError	331	Classification	Could not load/found valid validation doc for classification with category {classification_category} and type {classification_type}
109	HTTP 200 OK	TechnicalError	332	Classification	In case of VAT exemption sum of E3 classifications' amounts and sum of VAT classifications' vat amounts must be equal to invoice total net value plus taxes to be classified plus excluded vat amount
110	HTTP 200 OK	TechnicalError	333	Classification	Sum of E3 classifications' amounts must be equal to invoice total net value plus taxes to be classified
111	HTTP 200 OK	TechnicalError	334	Classification	Combination vatCategory {field1} , vatExemptionCategory {field2} : In case of without VAT obligation, a classification with similar VAT exemption category, VAT category of 24% or 17% and classification type 366 is required [Possible {field1} values: {'null', [1-8]] [Possible {field2} values: {'null', [Εύρος τιμών των αιτών

					<i>εξαιρέσης από το σχετικό παράρτημα}}</i>
112	HTTP 200 OK	TechnicalError	335	Classification	SendExpensesClassificationPerInvoice method is not supported for fuel invoices or invoices of type 1.5
113	HTTP 200 OK	TechnicalError	336	Classification	In case of VAT exemption a percentage of vat amount must be referred in E3 classification with category 2.5
114	HTTP 200 OK	TechnicalError	337	Classification	Combination vatCategory {field1}, vatExemptionCategory {field2}: Fields vatAmount, vatCategory and vatExemptionCategory must be null when classifications are posted per line <i>[Possible {field1} values: {'null', [1-8]]</i> <i>[Possible {field2} values: {'null', [εύρος τιμών των αιτιών εξαίρεσης ΦΠΑ από το σχετικό πίνακα του παραρτήματος]]</i>
115	HTTP 200 OK	TechnicalError	338	Classification	Classification is forbidden for invoice row {linenumber} because of its recType or its detailType Value
116	HTTP 200 OK	TechnicalError	339	Classification	{msg} classification is forbidden for invoice row {linenumber} because of its detailType value <i>[Possible {msg} values: {'incomeClassification', 'expensesClassification'}]</i>
117	HTTP 200 OK	TechnicalError	340	Classification	ClassificationPostMode field must not be contained in xml
118	HTTP 200 OK	ValidationError	341	Classification	Expenses VAT classification code NOT_VAT_295 is not allowed to be posted for invoices of type 14.1 and 14.3
119	HTTP 200 OK	ValidationError	401	Invoice	Resending payments methods is not allowed for initial's invoice type
120	HTTP 200 OK	ValidationError	402	Payment	At least one payment method detail must be of POS type
121	HTTP 200 OK	ValidationError	403	Payment	Invoice with MARK {mark} was sent by provider. Payment Methods must contain provider signature
122	HTTP 200 OK	ValidationError	404	Payment	Invoice with MARK {mark} was sent by ERP. Payment Methods must not contain provider signature"
123	HTTP 200 OK	ValidationError	405	Payment	Invoice with MARK {mark} was sent by provider. Payment Methods must not contain ECR token"
124	HTTP 200 OK	ValidationError	406	Payment	Invoice with MARK {mark} was sent by ERP. Payment Methods must contain ECR token
125	HTTP 200 OK	ValidationError	407	Payment	Payment Methods total amount must be equal to or less than initial invoice's total value
126	HTTP 200 OK	ValidationError	408	Payment	Invoice with MARK {invoice_mark}: Payment Methods cannot be resent for invoices created by timologio application
127	HTTP 200 OK	TechnicalError	-	-	Unexpected condition error



## 8 Appendix

### 8.1 Invoice type

<b>Domestic/Foreign Issuer Mirrored Accounting Source Documents</b>	<b>Code</b>	<b>Description</b>
Sales Invoice		
	1.1	Sales Invoice
	1.2	Sales Invoice/Intra-community Supplies
	1.3	Sales Invoice/Third Country Supplies
	1.4	Sales Invoice/Sale on Behalf of Third Parties
	1.5	Sales Invoice/Clearance of Sales on Behalf of Third Parties – Fees from Sales on Behalf of Third Parties
	1.6	Sales Invoice/Supplemental Accounting Source Document
Service Rendered Invoice		
	2.1	Service Rendered Invoice
	2.2	Intra-community Service Rendered Invoice
	2.3	Third Country Service Rendered Invoice
	2.4	Service Rendered Invoice/Supplemental Accounting Source Document

Proof of Expenditure		
	3.1	Proof of Expenditure (non-liaible Issuer)
	3.2	Proof of Expenditure (denial of issuance by liable Issuer)
For Future Use		
Credit Invoice		
	5.1	Credit Invoice/Associated
	5.2	Credit Invoice/Non-Associated
Invoice for Self-Delivery and Self-Supply		
	6.1	Self-Delivery Record
	6.2	Self-Supply Record
Contract – Income		
	7.1	Contract – Income
Special Record (Income) – Collection/Payment Receipt		
	8.1	Rents – Income
	8.2	Climate Crisis Resilience Fee
	8.4	Receipt of Payment POS
	8.5	Return Receipt POS
Purchase Order		

	8.6	Focused Purchase Order
Delivery Document		
	9.3	Dispatch Note

<b>Domestic/Foreign Recipient Non-Mirrored Accounting Source Documents</b>		
Retail Accounting Source Documents		
	11.1	Retail Sales Receipt
	11.2	Service Rendered Receipt
	11.3	Simplified Invoice
	11.4	Retail Sales Credit Note
	11.5	Retail Sales Receipt on Behalf of Third Parties
For Future Use	12	
<b>Domestic/Foreign Recipient Non-Mirrored Accounting Source Documents</b>		
Retail Accounting Source Documents Reception		
	13.1	Expenses – Domestic/Foreign Retail Transaction Purchases
	13.2	Domestic/Foreign Retail Transaction Provision
	13.3	Shared Utility Bills
	13.4	Subscriptions
	13.30	Self-Declared Entity Accounting Source Documents (Dynamic)
	13.31	Domestic/Foreign Retail Sales Credit Note
<b>Domestic/Foreign Recipient Mirrored Accounting Source Documents</b>		
Domestic/Foreign Excepted Entity Accounting Source Documents		
	14.1	Invoice/Intra-community Acquisitions
	14.2	Invoice/Third Country Acquisitions
	14.3	Invoice/Intra-community Services Receipt

	14.4	Invoice/Third Country Services Receipt
	14.5	EFKA
	14.30	Self-Declared Entity Accounting Source Documents (Dynamic)
	14.31	Domestic/Foreign Credit Note
Contract – Expense		
	15.1	Contract-Expense
Special Record (Expense) – Payment Receipt		
	16.1	Rent-Expense
<b>Input/Output Adjustment/Regularisation Entries</b>		
Entity Entries		
	17.1	Payroll
	17.2	Amortisations
	17.3	Other Income Adjustment/Regularisation Entries – Accounting Base
	17.4	Other Income Adjustment/Regularisation Entries – Tax Base
	17.5	Other Expense Adjustment/Regularisation Entries – Accounting Base
	17.6	Other Expense Adjustment/Regularisation Entries – Tax Base

## 8.2 VAT category

1	VAT rate 24%	24%
2	VAT rate 13%	13%
3	VAT rate 6%	6%
4	VAT rate 17%	17%
5	VAT rate 9%	9%
6	VAT rate 4%	4%
7	Without VAT	0%
8	Records without VAT (e.g. Payroll, Amortisations)	-
9	VAT rate 3% (Article 31, Law 5057/2023)	3%
10	VAT rate 4% (Article 31, Law 5057/2023)	4%

## 8.3 VAT Exemption Cause

Code	Description	Code	Description
1	Without VAT - article 3 of the VAT code	13	Without VAT - article 27.1.y - Seagoing Vessels of the VAT code
2	Without VAT - article 5 of the VAT code	14	Without VAT - article 28 of the VAT code
3	Without VAT - article 13 of the VAT code	15	Without VAT - article 39 of the VAT code
4	Without VAT - article 14 of the VAT code	16	Without VAT - article 39a of the VAT code
5	Without VAT - article 16 of the VAT code	17	Without VAT - article 40 of the VAT code
6	Without VAT - article 19 of the VAT code	18	Without VAT - article 41 of the VAT code
7	Without VAT - article 22 of the VAT code	19	Without VAT - article 47 of the VAT code
8	Without VAT - article 24 of the VAT code	20	VAT included - article 43 of the VAT code
9	Without VAT - article 25 of the VAT code	21	VAT included - article 44 of the VAT code
10	Without VAT - article 26 of the VAT code	22	VAT included - article 45 of the VAT code

11	Without VAT - article 27 of the VAT code	23	VAT included - article 46 of the VAT code
12	Without VAT - article 27 - Seagoing Vessels of the VAT code	24	Without VAT - article 6 of the VAT code
25	Without VAT - ΠΟΛ.1029/1995	26	Without VAT - ΠΟΛ.1167/2015
27	Without VAT – Other VAT exceptions	28	Without VAT - Article 24 (b) (1) of the VAT Code (Tax Free)
29	Without VAT - Article 47b of the VAT Code (OSS non-EU scheme)	30	Without VAT - Article 47c of the VAT Code (OSS EU scheme)
31	Excluding VAT - Article 47d of the VAT Code (IOSS)		

---

## 8.4 Withholding taxes

Code	Description	Tax
1	Case b' – Interests – 15%	15%
2	Case c' – Royalties – 20%	20%
3	Case d' – Management Consultant Fees – 20%	20%
4	Case d' – Technical Projects – 3%	3%
5	Liquid fuel and tobacco industry products - 1%	1%
6	Other Goods – 4%	4%
7	Services Provision – 8%	8%
8	4% Architect and Engineer Tax on Contractual Fees to Draft Surveys and Plans, Payable in Advance	4%
9	10% Architect and Engineer Tax on Contractual Fees for any other Project, Payable in Advance	10%
10	15% Attorney Fee Tax, Payable in Advance	15%
11	Payroll Tax Withholding (Article 15 paragraph 1 of Law 4172/2013)	amount
12	Merchant Marine Officers Payroll Tax Withholding (article 15 paragraph 2 of Law 4172/2013)	15%
13	Merchant Marine Lower-ranking Crew Payroll Tax Withholding (article 15 paragraph 2 of Law 4172/2013)	10%
14	Special Solidarity Contribution Withholding	amount
15	Compensation for Termination of Employment Tax Withholding (Article 15 paragraph 3 of Law 4172/2013)	amount
16	Withholding of foreign transactions based on avoidance agreements double taxation	amount
17	Other TAX deductions	amount
18	Withholding Tax on Dividends para.a par. 1 no. 4172/2013	5%

## 8.5 Other taxes

Code	Cases % of other taxes	% Other taxes	Notes
1	a1) 20% fire insurance premiums	15%	From the current version it will not be possible to send with this value.
2	a2) 20% fire insurance premiums	5%	From



			the current version it will not be possible to send with this value.
3	b) 4% life insurance premiums	4%	
4	c) 15% other insurance premiums	15%	
5	d) 0% tax-exempt insurance premiums	0%	
6	Hotels 1-2 stars 0,50 €	amount	
7	Hotels 3 stars 1,50 €	amount	
8	Hotels 4 stars 3,00 €	amount	
9	Hotels 5 stars 4,00 €	amount	
10	Rental rooms - Furnished rooms - Apartments 0,50 €	amount	
11	Special 5% tax on tv-broadcast commercials (EFTD)	5%	
12	10% luxury tax on the taxable value of intra-community acquired goods and those imported from third countries	10%	
13	10% luxury tax on the selling price before VAT for domestically produced goods	10%	
14	80% Public fees on the admission ticket price for casinos	80%	
15	Fire industry insurance premiums 20%	20%	
16	Customs duties- Taxes	amount	
17	Other Taxes	amount	
18	Charges of other Taxes	amount	
19	Special consumption tax	amount	
20	Hotels 1-2 stars €1.50 (per room/unit)	amount	
21	Hotels 3 stars €3,00 (per room/unit)	amount	
22	Hotels 4 stars €7,00 (per room/unit)	amount	
23	Hotels 5 stars €10,00 (per room/unit)	amount	
24	Furnished rental rooms – apartments €1,50 (per room/unit)	amount	
25	Short-term rental properties €1.50	amount	
26	Short-term rental properties (single-family homes over 80 sq.m.) €10.00	amount	
27	Self-catering accommodations – tourist furnished villas €10.00	amount	
28	Short-term rental properties €0.50	amount	
29	Short-term rental properties (single-family homes over 80 sq.m.) €4.00	amount	
30	Self-catering accommodations – tourist furnished villas €4.00	amount	

## 8.6 Stamp duty

Code	Description	Tax
1	Rate 1,2 %	1,20%
2	Rate 2,4 %	2,40%
3	Rate 3,6 %	3,60%
4	Charges of other Taxes	amount

## 8.7 Fees

Code	Description	Tax
1	12% for monthly bills of up to €50	12,00%
2	15% for monthly bills of between €50.01 and 100	15,00%
3	18% for monthly bills of between €100.01 and €150	18,00%
4	20% for monthly bills of over €150	20,00%
5	Prepaid telephony fee of 12% on the speaking time	12,00%
6	10% subscription television fee	10,00%
7	5% landline subscriber fee	5,00%
8	Ecotax and Plastic bag tax (Article 6A of Law 2339/2001)	amount
9	2% olive fruit fly control contribution	2,00%
10	Other Fees	amount
11	Fees for other Taxes	amount
12	Olive fruit fly control Contribution	amount
13	For monthly bill of each connection (10%)	10%
14	Prepaid fee on the value of airtime (10%)	10%
15	Mobile and prepaid fees for individuals aged 15 to 29 (0%)	0%
16	Environmental protection levy on plastic products 0.04 cents per piece [Article 4 of Law 4736/2020]	amount
17	Recycling fee 0.08 cents per piece [Article 80 of Law 4819/2021]	amount
18	Visitors' residence tax	amount
19	Tax on the gross receipts of restaurants and similar establishments	amount
20	Tax on the gross receipts of entertainment centres	amount
21	Tax on the gross revenue of casinos	amount
22	Other charges on gross revenue	amount

## 8.8 Income Classification Category

Code	Description
category1_1	Commodity Sale Income (+)/(-)

category1_2	Product Sale Income (+)/(-)
category1_3	Provision of Services Income (+)/(-)
category1_4	Sale of Fixed Assets Income (+)/(-)
category1_5	Other Income/Profits (+)/(-)
category1_6	Self-Deliveries/Self-Supplies (+)/(-)
category1_7	Income on behalf of Third Parties (+)/(-)
category1_8	Past fiscal years income (+)/(-)
category1_9	Future fiscal years income (+)/(-)
category1_10	Other Income Adjustment/Regularisation Entries (+)/(-)
category1_95	Other Income-related Information (+)/(-)
category3	Delivery

## 8.9 Income Classification Type

Code	Description
E3_106	Self-Production of Fixed Assets – Self-Deliveries – Destroying inventory/Commodities
E3_205	Self-Production of Fixed Assets – Self-Deliveries – Destroying inventory/Raw and other materials
E3_210	Self-Production of Fixed Assets – Self-Deliveries – Destroying inventory/Products and production in progress
E3_305	Self-Production of Fixed Assets – Self-Deliveries – Destroying inventory/Raw and other materials
E3_310	Self-Production of Fixed Assets – Self-Deliveries – Destroying inventory/ Products and production in progress
E3_318	Self-Production of Fixed Assets – Self-Deliveries – Destroying inventory/Production expenses
E3_561_001	Wholesale Sales of Goods and Services – for Traders
E3_561_002	Wholesale Sales of Goods and Services pursuant to article 39a paragraph 5 of the VAT Code (Law 2859/2000)
E3_561_003	Retail Sales of Goods and Services – Private Clientele
E3_561_004	Retail Sales of Goods and Services pursuant to article 39a paragraph 5 of the VAT Code (Law 2859/2000)
E3_561_005	Intra-Community Foreign Sales of Goods and Services
E3_561_006	Third Country Foreign Sales of Goods and Services
E3_561_007	Other Sales of Goods and Services
E3_562	Other Ordinary Income
E3_563	Credit Interest and Related Income
E3_564	Credit Exchange Differences
E3_565	Income from Participations
E3_566	Profits from Disposing Non-Current Assets
E3_567	Profits from the Reversal of Provisions and Impairments
E3_568	Profits from Measurement at Fair Value
E3_570	Extraordinary income and profits
E3_595	Self-Production Expenses
E3_596	Subsidies - Grants
E3_597	Subsidies – Grants for Investment Purposes – Expense Coverage
E3_880_001	Wholesale Sales of Fixed Assets
E3_880_002	Retail Sales of Fixed Assets
E3_880_003	Intra-Community Foreign Sales of Fixed Assets
E3_880_004	Third Country Foreign Sales of Fixed Assets
E3_881_001	Wholesale Sales on behalf of Third Parties
E3_881_002	Retail Sales on behalf of Third Parties
E3_881_003	Intra-Community Foreign Sales on behalf of Third Parties
E3_881_004	Third Country Foreign Sales on behalf of Third Parties
E3_598_001	Sales of goods belonging to excise duty
E3_598_003	Sales on behalf of farmers through an agricultural cooperative e.t.c.

## 8.10 Expenses Classification Category

Code	Description
category2_1	Commodity Purchases (+)/(-)
category2_2	Raw and Adjuvant Material Purchases (+)/(-)
category2_3	Services Receipt (+)/(-)
category2_4	General Expenses Subject to VAT Deduction (+)/(-)
category2_5	General Expenses Not Subject to VAT Deduction (+)/(-)
category2_6	Personnel Fees and Benefits (+)/(-)
category2_7	Fixed Asset Purchases (+)/(-)
category2_8	Fixed Asset Amortisations (+)/(-)
category2_9	Expenses on behalf of Third Parties (+)/(-)
category2_10	Past fiscal years expenses (+)/(-)
category2_11	Future fiscal years expenses (+)/(-)
category2_12	Other Expense Adjustment/Regularisation Entries (+)/(-)
category2_13	Stock at Period Start (+)/(-)
category2_14	Stock at Period End (+)/(-)
category2_95	Other Expense-related Information (+)/(-)

## 8.11 Expenses Classification Type

Code	Description
E3_101	Commodities at Period Start
E3_102_001	Fiscal Year Commodity Purchases (net amount)/Wholesale
E3_102_002	Fiscal Year Commodity Purchases (net amount)/Retail
E3_102_003	Fiscal Year Commodity Purchases (net amount)/Goods under article 39a paragraph 5 of the VAT Code (Law 2859/2000)
E3_102_004	Fiscal Year Commodity Purchases (net amount)/Foreign, Intra-Community
E3_102_005	Fiscal Year Commodity Purchases (net amount)/Foreign, Third Countries
E3_102_006	Fiscal Year Commodity Purchases (net amount)/Others
E3_104	Commodities at Period End
E3_201	Raw and Other Materials at Period Start/Production
E3_202_001	Fiscal Year Raw and Other Material Purchases (net amount)/Wholesale
E3_202_002	Fiscal Year Raw and Other Material Purchases (net amount)/Retail
E3_202_003	Fiscal Year Raw and Other Material Purchases (net amount)/ Foreign, Intra-Community

E3_202_004	Fiscal Year Raw and Other Material Purchases (net amount)/ Foreign, Third Countries
E3_202_005	Fiscal Year Raw and Other Material Purchases (net amount)/Others
E3_204	Raw and Other Material Stock at Period End/Production
E3_207	Products and Production in Progress at Period Start/Production

E3_209	Products and Production in Progress at Period End/Production
E3_301	Raw and Other Material at Period Start/Agricultural
E3_302_001	Fiscal Year Raw and Other Material Purchases (net amount)/Wholesale
E3_302_002	Fiscal Year Raw and Other Material Purchases (net amount)/Retail
E3_302_003	Fiscal Year Raw and Other Material Purchases (net amount)/Foreign, Intra-Community
E3_302_004	Fiscal Year Raw and Other Material Purchases (net amount)/Foreign, Third Countries
E3_302_005	Fiscal Year Raw and Other Material Purchases (net amount)/Others
E3_304	Raw and Other Material Stock at Period End/Agricultural
E3_307	Products and Production in Progress at Period Start/ Agricultural
E3_309	Products and Production in Progress at Period End/ Agricultural
E3_312	Stock at Period Start (Animals-Plants)
E3_313_001	Animal-Plant Purchases (net amount)/Wholesale
E3_313_002	Animal-Plant Purchases (net amount)/Retail
E3_313_003	Animal-Plant Purchases (net amount)/ Foreign, Intra-Community
E3_313_004	Animal-Plant Purchases (net amount)/ Foreign, Third Countries
E3_313_005	Animal-Plant Purchases/Others
E3_315	Stock at Period End (Animals-Plants)/Agricultural
E3_581_001	Employee Benefits/Gross Earnings
E3_581_002	Employee Benefits/Employer Contributions
E3_581_003	Employee Benefits/Other Benefits
E3_582	Asset Measurement Damages
E3_583	Debit Exchange Differences
E3_584	Damages from Disposing-Withdrawing Non-Current Assets
E3_585_001	Foreign/Domestic Management Fees
E3_585_002	Expenditures from Linked Enterprises
E3_585_003	Expenditures from Non-Cooperative States or Privileged Tax Regimes
E3_585_004	Expenditures for Information Day-Events
E3_585_005	Reception and Hospitality Expenses
E3_585_006	Travel expenses
E3_585_007	Self-Employed Social Security Contributions
E3_585_008	Commission Agent Expenses and Fees on behalf of Farmers
E3_585_009	Other Fees for Domestic Services
E3_585_010	Other Fees for Foreign Services
E3_585_011	Energy
E3_585_012	Water
E3_585_013	Telecommunications
E3_585_014	Rents
E3_585_015	Advertisement and promotion
E3_585_016	Other expenses
E3_586	Debit interests and related expenses
E3_587	Amortisations
E3_588	Extraordinary expenses, damages and fines

E3_589	Provisions (except for Personnel Provisions)
E3_882_001	Fiscal Year Tangible Asset Purchases/Wholesale
E3_882_002	Fiscal Year Tangible Asset Purchases/Retail
E3_882_003	Fiscal Year Tangible Asset Purchases/ Intra-Community Foreign
E3_882_004	Fiscal Year Tangible Asset Purchases/ Third Country Foreign
E3_883_001	Fiscal Year Intangible Asset Purchases/Wholesale
E3_883_002	Fiscal Year Intangible Asset Purchases/Retail
E3_883_003	Fiscal Year Intangible Asset Purchases/ Intra-Community Foreign
E3_883_004	Fiscal Year Intangible Asset Purchases/ Third Country Foreign
VAT_361	Domestic Purchases & Expenditures
VAT_362	Purchases & Imports of Investment Goods (Fixed Assets)
VAT_363	Other Imports except for Investment Goods (Fixed Assets)
VAT_364	Intra-Community Goods Acquisitions
VAT_365	Intra-Community Services Receipts per article 14.2.a
VAT_366	Other Recipient Actions
E3_103	Impairment of goods
E3_203	Impairment of raw materials and supplies
E3_303	Impairment of raw materials and supplies
E3_208	Impairment of products and production in progress
E3_308	Impairment of products and production in progress
E3_314	Impairment of animals-plants - goods
E3_106	Own production of fixed assets – Self Deliveries – Inventory Disasters
E3_205	Own production of fixed assets - Self Deliveries – Inventory Disasters
E3_305	Own production of fixed assets - Self Deliveries – Inventory Disasters
E3_210	Own production of fixed assets - Self Deliveries – Inventory Disasters
E3_310	Own production of fixed assets - Self Deliveries – Inventory Disasters
E3_318	Own production of fixed assets - Self Deliveries – Inventory Disasters
E3_598_002	Purchases of goods falling into excise duty
NOT_VAT_295	Non-participation in VAT (expenses – inputs F2)

## 8.12 Payment methods

Code	Description
1	Domestic Payments Account Number
2	Foreign Payments Account Number
3	Cash
4	Check
5	On credit
6	Web Banking
7	POS / e-POS
8	Direct Payments IRIS



### 8.13 Unit of measurement

Code	Description
1	Pieces
2	Kg
3	Litres

### 8.14 Purpose of movement

Code	Description
1	Sale
2	Sales on Behalf of Third Parties
3	Sampling
4	Exhibition
5	Return
6	Keeping
7	Edit - Assembly
8	Between Entity Branches
9	Purchase
10	Supply of ships and aircraft
11	Free distribution
12	Warranty
13	Loan
14	Storage by Third Party
15	Return from Custody
16	Recycling
17	Destruction of waste material
18	Fixed Asset Movement (Internal Circulation)

### 8.15 Remark

Code	Description
1	Third Party Sales Clearance
2	Fee from Third Party Sales

## 8.16 Line Type

Code	Description	Remarks
1	Withholding Taxes Special Line	Inactive- For Future Use
2	End line with VAT	
3	Other Taxes Line with VAT	
4	Special Stamp Line	Inactive- For Future Use
5	Special Booking Line	Inactive- For Future Use
6	Gift Certificate	
7	Negative sign of values	Valid only in the cases of documents 17.3, 17.4, 17.5 and 17.6 and indicates that the amounts of the line values are negative

## 8.17 Fuel Codes

Code	Description	Notes
10	Benzine 95RON	
11	Benzine 95RON+	
12	Benzine 100RON	
13	Benzine LRP	
14	Airplane Gasoline	
15	Special Jet Fuel	
20	Diesel	
21	Diesel premium	
30	Diesel Heatn	
31	Diesel Heat premium	
32	Diesel Light	
33	Diesel for other uses	
34	Diesel shipping	
35	Kerosene JP1	
36	Kerosene for other uses	
37	Crude Oil	
38	Crude Oil shipping	
40	LPG (liquid gas)	
41	Liquid gas (LPG) and industrial methane/commercial engines (in bulk)	
42	Liquid gas (LPG) and heating methane and other uses (in bulk)	
43	Liquid gas (LPG) and industrial methane/commercial engines (in bottles)	
44	Liquid gas (LPG) and heating methane and other uses (in bottles)	
50	CNG (compressed natural gas)	
60	Aromatic Hydrocarbons Tariff Class 2707	
61	Circular Hydrocarbons Tariff Class 2902	
70	Light kerosene (WHITE SPIRIT)	
71	Light Oils	
72	Biodiesel	
999	Other service charges	Used in cases where in a document, apart from fuel, there is a need to invoice other charges of small amounts

## 8.18 Document Deviation Type

Code	Description	Notes
1	Transmission of an omission by the Recipient	This value is used for Data Transmission by the Recipient due to Failure to Transmit by the Issuer. <b><u>Allowed document types: 1.1, 1.6, 2.1, 2.4, 5.2, 8.1 and 8.2</u></b>
2	Transmission of an omission by an Issuer	This value is used for Data Transmission by the Issuer, in case the Issuer agrees with the Recipient's indication that the (issuer's) failure to transmit has been indicated. <b><u>Allowed document types: 11.3, 11.4, 13.1, and 13.31</u></b>
3	Transmission of Deviation from Recipient	This value is used for Data Transmission (non-received documents) by the Recipient due to a Data Transmission Deviation by the Issuer <b><u>Allowed document types: 11.3, 11.4, 13.1, and 13.31 (Especially and exclusively for documents issued in 2021, types 1.1 and 5.2 are additionally allowed)</u></b>
4	Transmission of Deviation from Publisher	This value is used for Data Transmission by the Issuer, in case it agrees with the Recipient's marking of "Transmission Deviation" in the counterpart A1 Document Type that it had transmitted to the Recipient. <b><u>Allowed Document Types: 11.3, 11.4, 13.1, and 13.31</u></b>

## 8.19 Special Document Category

Code	Description	Notes
1	Subsidies - Grants	
2	Hotel Retail Revenue - <del>Room Charges</del>	
3	Accounting Registration	
4	Tax Free	Valid value only for

		transmission via erp or version via provider or timologio
5	Complex domestic-international transactions	
6	Beneficiaries of Article 3 of the information under reference 139818 EΞ2022/28.09.2022 (Official Gazette 5083) of the joint ministerial decision	
7	Purchase of agricultural goods and services, Article 41 of the VAT Code	
8	Retail Revenues FEM AADE_1	For reading only - not valid for transmission via ERP / Provider
9	Retail Revenues FEM AADE_2	For reading only - not a valid value for transmission via ERP / Provider
10	Retail Revenues FEM Business Deviation	
11	Heating Allowance	
12	Food transactions	

## 8.20 Entity Type Category

Code	Description	Notes
1	Tax Representative	
2	Intermediary	
3	Carrier	
4	The Consignee (Seller)	
5	The Sender (Seller)	
6	Other Correlated Entities	

## 9 History of changes

### 9.1 Version 0.5.1

Changes until 10/10/2019

- Additions

---

– Par. 5.2 : Field declarations

- Par. 6.2 : Response format in invoices retrieval
- Par. 7.1 : Errors description
- Appendix: Tables 8.10, 8.12
- Updates
  - Par. 4.3.2, 4.3.3 : Classifications
  - Par 4.3.2, 4.3.3, 5, 5.1, 5.1.1, 5.2, 5.3, 5.4, 6.1, 6.2 : Fields marked as optional
  - Par. 4.3.4 : Way of calling invoices retrieval service
  - Par. 8.1 : Change of codes at sales invoices

## 9.2 Version 0.6

Changes until 20/03/2020

- Additions
  - Par. 4.3.4 : Method CancellInvoice
  - Par. 4.3.6 : Method RequestTransmittedDocs
  - Par. 5.3, 5.7, 5.8: New types added
  - Par 5.4: Fields additions
  - Par 7.2: Error code additions
  - Appendix 8.12: Payment methods
- Updates
  - Par. 4.3.2 : Method SendIncomeClassification – Model changed
  - Par. 4.3.3 : Method SendExpensesClassification – Model changed
  - Par. 4.3.5 : Method RequestDocs – New name and functionality
  - Par. 5, 5.2, 5.2.1, 5.4, 5.5, 5.6, 6.1, 6.2: Fields added or changed
  - Par. 7.2: New error codes added
  - Appendix 8.1, 8.2, 8.8, 8.9, 8.10, 8.11, 8.12 : Tables updated
    - Par. 5.6 : Field Changes taxType, taxCategory
    - Par. 4.3.3 : Method SendExpensesClassification – Model Changes
    - Par .5.3 : Change Field Type AA
    - Par. 5.4 : Subtraction field booking rate
    - Pan. 8.12 : Changes to Payment Method Descriptions

### 9.3 Version 0.6.1

Changes up to 10/07/2020

- Additions
  - Par. 4.2 : Descriptions of Provider Functions
  - Par. 4.5.7 : Method RequestTransmittedDocs (providers)
  - Par. 6.2.1 : Case of Receiving Data for User Other than Electronic Invoicing Providers
  - Par. 6.2.2 : Case of Receiving Data for Electronic Invoicing Providers through the method RequestedTransmittedDocs
  
- Updates
  - Par. 4: Description API
  - Par. 4.5.1 : Method Send Invoice
  - Par. 7.2: Add error codes and change the message description of code 202
  - Par. 5: Add Field (transmission Failure)
  - Par. 5.3: Maximum allowable length (50) for field series and aa
  - Par. 6.1: Add Field(authentication Code)

### 9.4 Version 1.0

Change up to 20/07/2020

- Updates
  - Par. 4.2 : Removal of Provider Functions
  - Par. 4.5.7 : Removal of Provider Functions RequestTransmittedDocs (providers)
  - Par. 5.7: Revenue Characterization (classification Type became optional)
  - Par. 6.2.1 : Removal of Data Receipt case for users other than electronic billing Providers
  - Par.6.2.2 : removal of Data receipt Case for Electronic Invoicing Providers through the method RequestedTransmittedDocs

## 9.5 Version 1.0.1

Changes up to 01/10/2020

- Additions
  - Par. 4.3 : Add URLs calling the methods of the productive environment
  - Par. 7.2: Add Business error codes
- Updates
  - Par.4.2.1: Update user registration process in the production environment

## 9.6 Version 1.0.2

Changes up to 11/11/2020

- Additions
  - Par. 4.3.2, 4.3.3: Add new field(entityVatNumber – Reference Entity Tax Indefication number)
  - Par. 5.4: Add new field(recType – Line Type) and explanation on “Remarks” of the paragraph, regarding the way of sending lines with fees or other taxes with VAT
  - Par. 7.2: Add business error codes
  - Par. 8.3: Add VAT exclusion category (Excluding VAT – Article 6 of the Vat code)
  - Par. 8: Add new table 8.16 – Line Type
- Updates
  - Par. 7.2: Change the error code description 215
  - Par. 8.3: Rename the Category of reason for VAT exemption« Excluding VAT-Article 2 of the Vat code » to « Excluding VAT-Article 2 and 3 of theVat code »
  - Par. 4.3.4: Change the method of calling the method CancelInvoice, by adding a parameter
  - Par. 5: Update how to generate a document UID



## 9.7 Version 1.0.3

Changes up to 01/06/2021

- Additions
  - Par. 5.3: Add new Field (fuelInvoice – fuel document indication) and explanation in the “Remarks” of the paragraph, regarding the way of sending this field ( valid only for providers)
  - Par. 5.4: Add new field (fuelCode – Fuel code) and explanation in the “Remarks” of the paragraph of the field (**valid only for providers and fuel documents, fuelInvoice = true**)
  - Par. 7.2: Add business error codes
  - Par. 8.3 : Add categories of reason for VAT exemption
  - Par. 8.4 : Add with holding tax categories
  - Par. 8.5 : Add categories of other taxes
  - Par. 8.6 : Add a stamp category
  - Par. 8.7 : Add fee categories
  - Par. 8: Add new table 8.17 – Fuel Codes
- Updates
  - Par. 8.5: Add the Remarks column to the table and note that the other taxes sent with the prices:

Code	Cases% Other Taxes	% other Taxes
1	α1) Fire insurance premiums 20%	15%
2	α2) Fire insurance premiums 20%	5%

Are no longer allowed.

## 9.8 Version 1.0.4

### A) Changes up to 20/11/2021

- Additions
  - Par. 7.2 : Add business error codes
  - Par. 8.7 : Add fee categories
  - Par. 8.11: Add expense ,characterization type codes
  - Par. 8.12: Add payment methods
- Updates
  - Par. 4.3.2, 4.3.3: Change value range bin the field

transaction Mode

### B) Changes up to 13/12/2021

- Additions
  - Par. 7.2 : Add business error codes
  - Par. 8.9: Add revenue type codes
  - Par. 8.12: Add payment methods
- Updates
  - Par. 8.11: Remove expense type codes (E3\_598\_001,E3\_598\_003)

## 9.9 Version 1.0.5

### Changes up to 18/02/2022

- Additions
  - Par. 8.17: Add fuel codes
- Updates
  - Par. 4.3.5, 4.3.6: Add a reference to the parameter entityVatNumber

## 9.10 Version 1.0.6

Changes up to 28/06/2022

- Additions
  - Par. 4.3.7: Adding a method for receiving revenue data
  - Par 4.3.8: Adding a method to receive output data
  - Par. 5.1: Addition of a new field (documentIdNo - Official Document Number) and explanation in the "Remarks" of the paragraph
  - Par. 5.1: Addition of a new field (supplyAccountNo - Electricity Supply No.) and its explanation in the "Remarks" of the paragraph
  - Par. 5.3: Adding a new field (specialInvoiceCategory - Special Invoice Category)
  - Par. 5.3: Add new field (invoiceVariationType - Invoice Variation Type)
  - Par. 5.4: Addition of a new field (quantity15 - Temperature quantity 15 degrees)
  - Par. 5.4: Adding a new field (itemDescr - Item Description)
  - Par. 6.3: Adding a response to receive income - expenditure data
  - Par. 8.3 : Addition of categories of VAT exemption grounds.
  - Par. 8.4 : Addition of categories of withholding taxes
  - Par. 8.5 : Addition of categories of other taxes
  - Par. 8.7 : Addition of fee categories
  - Par. 8.17 : Add fuel code
  - Par. 8.18: Adding the price table: Special Document Category
  - Par. 8.19: Adding the price table: Deviation (Differentiation) Document Type
- Updates
  - Par. 4.3.5 : Adding parameters to the recipient's document search method
  - Par. 4.3.6 : Adding parameters to the document search method on behalf of the forwarder
  - Par. 5: The transactionFailure field is valid for both provider and ERP transmission depending on the value - the value range of the field has been changed
  - Par. 5.4: recType changed its value range - new maximum value 7 (negative sign of values) and explanation in the Notes of how to use it
  - Par. 7.2 : Change error text 309
  - Par. 8.5 : modify the description Customs Duties - Duties to Other Customs Duties – Duties

## 9.11 Version 1.0.7

Changes up to 17/10/2023

- Additions
  - Par. 5.1: Adding a new field (countryDocumentId - Country Code of Issuing Official Document) and explaining it in the "Comments" section of the

- paragraph
- Par. 5.3: Adding a new field (otherCorrelatedEntities - Other Correlated Entities, of type EntityType)
- Par. 5.3.1: Adding a new EntityType
- Par.5: Adding a new field (otherTransportDetails - Other Shipment Details, of type TransportDetailType)
- Par. 5.7: Adding a new TransportDetailType
- Par. 8.19: Adding values for Special Invoice Categories (SpecialInvoiceCategoryType)
- Par. 8.20: Adding the value table: Categories of Associated Entities
- Updates
  - Par. 4.2.3: New method invocation process
  - Par. 4.2.5: Enrichment of the information returned through the RequestDocs method call in cases where the contracting party rejected a document using the distinct method for sending expense attributes
  - Par. 8.19: Modification of the description from "Hotel Retail Revenues – Room Charges" to "Hotel Retail Revenues"

## 9.12 Version 1.0.8

Changes up to 12/02/2024

- Additions
  - Par. 4.2.4: Addition of the SendPaymentsMethod method
  - Par. 5.2.1: Addition of a new type ProviderSignatureType (Provider Payment Signature)
  - Par. 5.2.2: Addition of a new type ECRTokenType (Payment Signature for ECR with ERP System)
  - Par. 5.1: Addition of a new field (countryDocumentId - Country Code of Issuing Official Document) and its explanation in the 'Remarks' of the paragraph
  - Par. 5.3: Addition of a new field (otherDeliveryNoteHeader - Other General Delivery Elements, of type OtherDeliveryNoteHeaderType)
  - Par. 5.3: Addition of a new field (isDeliveryNote - Indication of Delivery Document) and its explanation in the 'Remarks' of the paragraph
  - Par. 5.3: Addition of a new field (otherMovePurposeTitle - Title of Other Delivery Purpose) and its explanation in the 'Remarks' of the paragraph
  - Par. 5.3: Addition of a new field (thirdPartyCollection - Third Party Collection Indication) and its explanation in the 'Remarks' of the paragraph
  - Par. **Σφάλμα! Το αρχείο προέλευσης της αναφοράς δεν βρέθηκε.:** Addition of a new type OtherDeliveryNoteHeaderType
  - Par. **Σφάλμα! Το αρχείο προέλευσης της αναφοράς δεν βρέθηκε.:** Addition of new fields (TaricNo, itemCode, otherMeasurementUnit Quantity, otherMeasurementUnitTitle)
  - Par. 6.4 : Addition of a method for receiving VAT information
  - Par. 7.2 : Addition of business error codes

- Par. **Σφάλμα! Το αρχείο προέλευσης της αναφοράς δεν βρέθηκε.**: Addition of document types (8.4, 8.5, 8.6, and 9.3)
  - Par. **Σφάλμα! Το αρχείο προέλευσης της αναφοράς δεν βρέθηκε.**: Addition of VAT Category Value (3%)
  - Par. **Σφάλμα! Το αρχείο προέλευσης της αναφοράς δεν βρέθηκε.**: Addition of income classification category code (category3)
  - Par. **Σφάλμα! Το αρχείο προέλευσης της αναφοράς δεν βρέθηκε.** Addition of measurement unit values (Meters, Square Meters, Cubic Meters, Pieces\_Other Cases)
  - Par. **Σφάλμα! Το αρχείο προέλευσης της αναφοράς δεν βρέθηκε.**: Addition of values for circulation purposes (values 9 to 19)
  - Par. **Σφάλμα! Το αρχείο προέλευσης της αναφοράς δεν βρέθηκε.** : Addition of values for Special Invoice Categories (SpecialInvoiceCategoryType)
  - Par. **Σφάλμα! Το αρχείο προέλευσης της αναφοράς δεν βρέθηκε.** : Addition of the table of values: Correlated Entities Categories
- Updates
    - Par. **Σφάλμα! Το αρχείο προέλευσης της αναφοράς δεν βρέθηκε.** : Enhancement of the information returned through the RequestDocs method call in cases where the contracting party rejected a document using the distinct method of sending expense classification
    - Par. 5: Update regarding the fields of the UID
    - Par. **Σφάλμα! Το αρχείο προέλευσης της αναφοράς δεν βρέθηκε.** : Payment Method: Addition of New Fields
    - Par. 7.2: Change of Text in Operational Errors 403, 404, 405, 406

### 9.13 Version 1.0.9

Changes up to 11/7/2024

- Additions
  - Par. 5.2 :Addition of a new field tid (POS tid Code) and explanation in the 'Notes' section of the paragraph
  - Par.5.3: Addition of the fields multipleConnectedMarks (Multiple Connected MARKs), tableAA (Table ID), totalCancelDeliveryOrders (Indicator of total cancellation of Order Slips) and their explanation in the 'Notes' section of the paragraph
  - Par. 5.4 : Addition of the field notVAT195 (Indicator of non-participation in VAT

- (income – outputs)) and its explanation in the 'Notes' section of the paragraph
- Par. 7.2 : Addition of operational error codes (Code 280 and Code 341)
  - Par. 8.2: Addition of VAT Category value (rate 4% - Article 31, Law 5057/2023)

- Par. 8.5 : Addition of other tax categories (new codes from 19 to 30)
  - Par. 8.11: Addition of expense classification type code (NOT\_VAT\_295)
  - Par. 8.12: Addition of payment method (Direct Payments IRIS)
- Updates
  - Par. 8.1: Renaming of document type 8.2
  - Par. 8.2: Completion of the name of VAT code 9 (rate 3% - Article 31, Law 5057/2023)